

The NAMC-MMC-REF has been designed by:

**N.A.T. GmbH
Konrad-Zuse-Platz 9
D-53227 Bonn**

Phone: +49 / 228 / 965 864 - 0

Fax: +49 / 228 / 965 864 - 10

Internet: <http://www.nateurope.com>

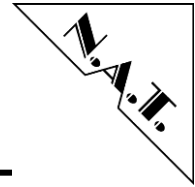

Disclaimer

The following documentation, compiled by N.A.T. GmbH (henceforth called N.A.T.), represents the current status of the product's development. The documentation is updated on a regular basis. Any changes which might ensue, including those necessitated by updated specifications, are considered in the latest version of this documentation. N.A.T. is under no obligation to notify any person, organization, or institution of such changes or to make these changes public in any other way.

We must caution you, that this publication could include technical inaccuracies or typographical errors.

N.A.T. offers no warranty, either expressed or implied, for the contents of this documentation or for the product described therein, including but not limited to the warranties of merchantability or the fitness of the product for any specific purpose.

In no event will N.A.T. be liable for any loss of data or for errors in data utilization or processing resulting from the use of this product or the documentation. In particular, N.A.T. will not be responsible for any direct or indirect damages (including lost profits, lost savings, delays or interruptions in the flow of business activities, including but not limited to, special, incidental, consequential, or other similar damages) arising out of the use of or inability to use this product or the associated documentation, even if N.A.T. or any authorized N.A.T. representative has been advised of the possibility of such damages.

The use of registered names, trademarks, etc. in this publication does not imply, even in the absence of a specific statement, that such names are exempt from the relevant protective laws and regulations (patent laws, trade mark laws, etc.) and therefore free for general use. In no case does N.A.T. guarantee that the information given in this documentation is free of such third-party rights.

Neither this documentation nor any part thereof may be copied, translated, or reduced to any electronic medium or machine form without the prior written consent from N.A.T. GmbH.

This product (and the associated documentation) is governed by the N.A.T. General Conditions and Terms of Delivery and Payment.

Note:

The release of the Hardware Manual is related to a certain HW board revision given in the document title. For HW revisions earlier than the one given in the document title please contact N.A.T. for the corresponding older Hardware Manual release.

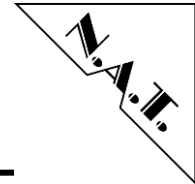
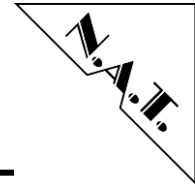

Table of Contents

DISCLAIMER	3
TABLE OF CONTENTS	4
LIST OF TABLES	5
LIST OF FIGURES	5
CONVENTIONS	6
1 INTRODUCTION	7
2 OVERVIEW	8
2.1 MAJOR FEATURES.....	8
2.2 BLOCK DIAGRAM	9
2.3 LOCATION DIAGRAM	10
3 BOARD FEATURES	11
3.1 ATMEL AVR _X MEGA128A4U MICROCONTROLLER	11
3.2 I ² C-DEVICES	11
3.3 SENSORS	12
3.3.1 <i>Temperature Sensors</i>	12
3.3.2 <i>Voltage Sensors</i>	12
3.4 HOT-SWAP-CIRCUITRY	12
3.5 DC/DC-CONVERTER.....	12
3.6 SERIAL INTERFACE	12
4 HARDWARE	13
4.1 FRONT PANEL AND LED	13
4.2 CONNECTORS AND SWITCHES	15
4.2.1 <i>CON1: AMC Connector</i>	16
4.2.2 <i>JP1: Microcontroller Programming Header</i>	18
4.2.3 <i>JP2 – JP6: Microcontroller Port Pins</i>	18
4.2.4 <i>S2: USB Connector</i>	19
4.2.5 <i>SW1: Hot Swap Switch</i>	19
5 BOARD SPECIFICATION	20
6 INSTALLATION	21
6.1 SAFETY NOTE	21
6.2 INSTALLATION PREREQUISITES AND REQUIREMENTS	22
6.2.1 <i>Requirements</i>	22
6.2.2 <i>Power supply</i>	22
6.2.3 <i>Automatic Power Up</i>	22
6.3 STATEMENT ON ENVIRONMENTAL PROTECTION	23
6.3.1 <i>Compliance to RoHS Directive</i>	23
6.3.2 <i>Compliance to WEEE Directive</i>	23
6.3.3 <i>Compliance to CE Directive</i>	24



6.3.4	<i>Product Safety</i>	24
6.3.5	<i>Compliance to REACH</i>	24
7	PIGGY BOARD	25
7.1	HARDWARE DESCRIPTION	26
7.2	FRONT PANEL	28
7.3	HEAT RESISTORS	29
7.4	PROGRAMMING THE BASEBOARD	30
8	KNOWN BUGS / RESTRICTIONS	30
APPENDIX A: REFERENCE DOCUMENTATION		31
APPENDIX B: DOCUMENT'S HISTORY		32

List of Tables

Table 1:	List of used abbreviations	6
Table 2:	AMC Connector – Pin Assignment	16
Table 3:	JP1: Microcontroller Programming Header – Pin Assignment	18
Table 4:	JP2: Microcontroller Port Pins – Pin Assignment	18
Table 5:	JP3: Microcontroller Port Pins – Pin Assignment	18
Table 6:	JP4: Microcontroller Port Pins – Pin Assignment	18
Table 7:	JP5: Microcontroller Port Pins – Pin Assignment	19
Table 8:	JP6: Microcontroller Port Pins – Pin Assignment	19
Table 9:	S2: USB Connector – Pin Assignment	19
Table 10:	NAMC-MMC-REF Specification – Overview	20
Table 11:	I2C Device List	27
Table 12:	Switch description	28
Table 13:	LED description	29

List of Figures

Figure 1:	NAMC-MMC-REF	7
Figure 2:	Block Diagram – Overview	9
Figure 3:	Location Diagram – Overview	10
Figure 4:	Notes for soldering LED connections	13
Figure 5:	Front Panel	14
Figure 6:	Connector and Switch Location – Overview	15
Figure 7:	NAMC-MMC-REF with piggy board	25
Figure 8:	AMC/uRTM Management Block Diagram [6]	26
Figure 9:	Piggy assembly drawing TOP side	27
Figure 10:	Piggy assembly drawing BOT side	27
Figure 11:	Front panel including piggy I/O	28

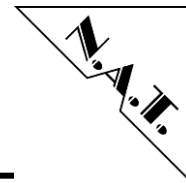

Conventions

If not otherwise specified, addresses and memory maps are written in hexadecimal notation, identified by *0x*.

The following table gives a list of the abbreviations used in this document.

Table 1: List of used abbreviations

Abbreviation	Description
ADC	Analog-Digital-Converter
AMC	Advanced Mezzanine Card
ATCA	Advanced Telecommunications Computing Architecture
DC	Direct Current
EEPROM	Electrically Erasable PROM
HPM	Hardware Platform Management
I ² C	Inter-Integrated Circuit
I/O	Input/Output
IPMI	Intelligent Platform Management Interface
LED	Light Emitting Diode
μTCA/MTCA	Micro Telecommunications Computing Architecture
MMC	Module Management Controller
PCI(e)	Peripheral Component Interconnect (Express)
PTC	Positive Temperature Coefficient
QFN	Quad Flat No Leads (Package)
USB	Universal Serial Bus

1 Introduction

Every AMC in a μ TCA-System must be equipped with a Module Management Controller (MMC) for communication via IPMI. It is mandatory for basic functionality like E-Keying, Hot-Swapping of modules etc.

The **NAMC-MMC-REF** features an MMC reference design in AMC form factor for evaluating IPMI software. It carries N.A.T.'s standard IPMI hardware block with focus on an Atmel AVRxmega128 microcontroller.

The following figure shows a photo of the **NAMC-MMC-REF**.

Figure 1: NAMC-MMC-REF

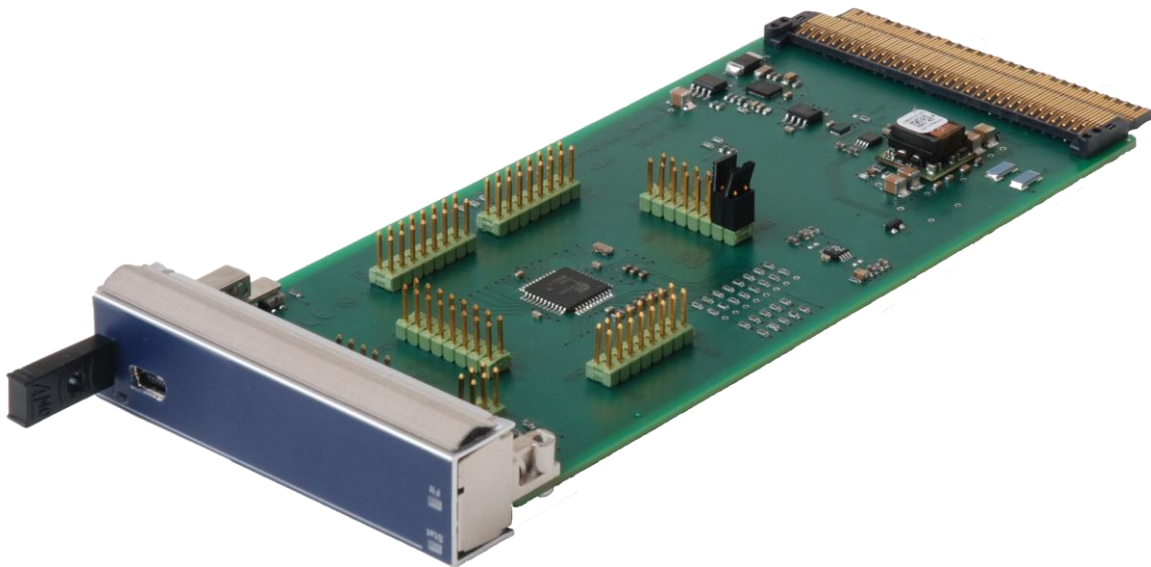

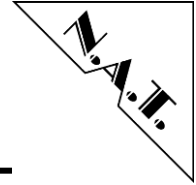

2 Overview

2.1 Major Features

- Atmel AVRxmega128A4U microcontroller, all pins are accessible via pin header
- Several I²C-Devices
- Temperature and voltage sensors
- Hot-Swap-Circuitry
- DC/DC-Converter (12V→3.3V), accessible via I²C
- Serial interface on front plate via Mini-USB jack (RS232 signals inside, no USB)

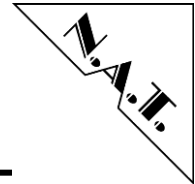

2.2 Block Diagram

The following figure shows a detailed block diagram of the **NAMC-MMC-REF**.

Figure 2: Block Diagram – Overview

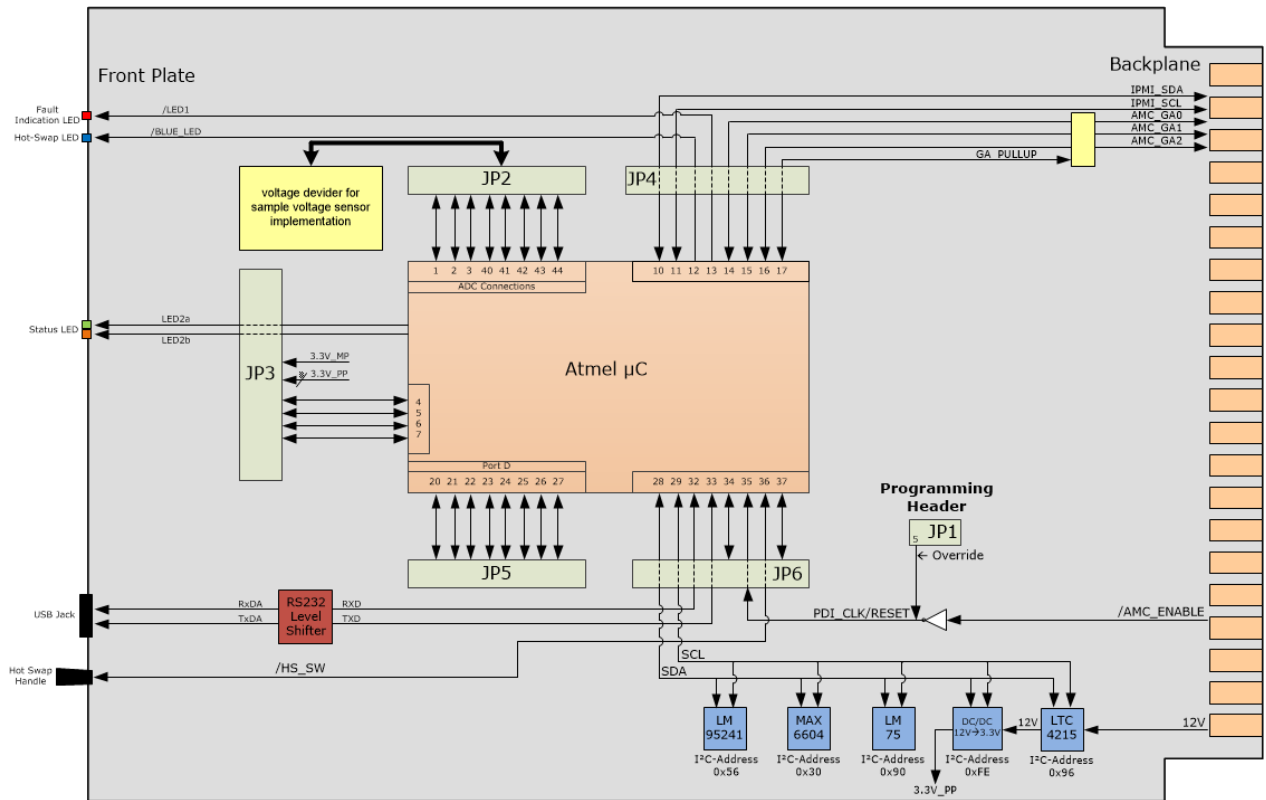

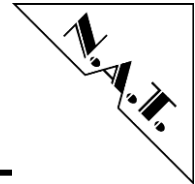

2.3 Location Diagram

The following figure shows the position of important components. Depending on the board type it might be that the board does not include all components named in the location diagram.

Figure 3: Location Diagram – Overview

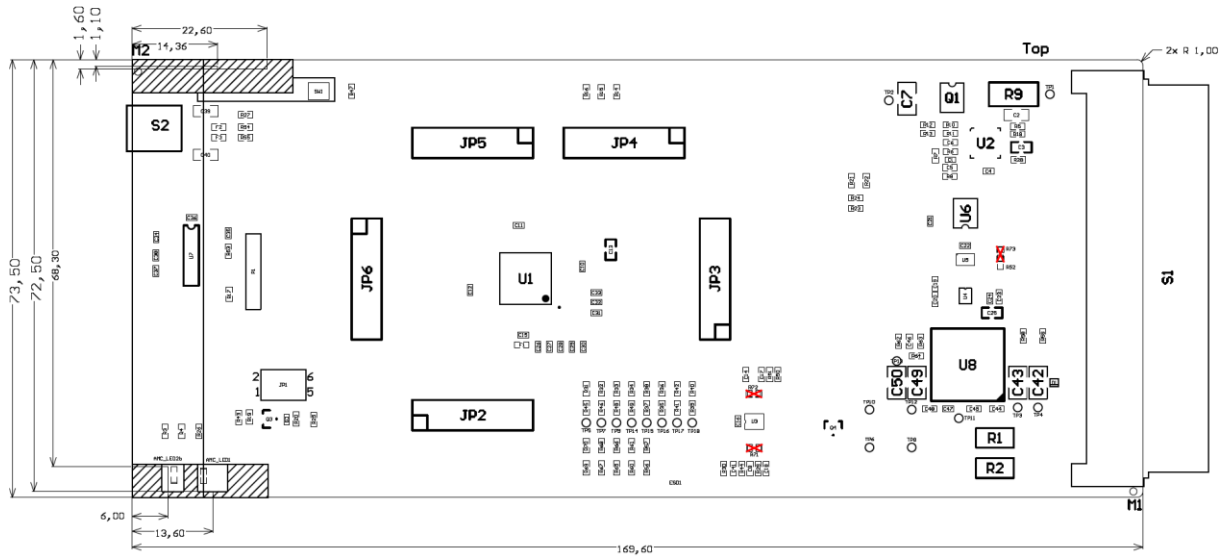

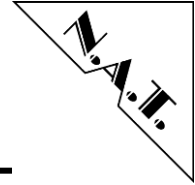

3 Board Features

The **NAMC-MMC-REF** can be divided into a number of functional blocks, which are described in the following paragraphs.

3.1 Atmel AVRxmega128A4U Microcontroller

There is a wide variety of chips available which suits nearly any demand of user I/O and memory.

For the IPMI controller design only a few requirements are mandatory:

- 2 x I²C interfaces for IPMI and board internal communication
- ADC inputs for sensors
- Minimum 16KByte of Flash Memory (64 Kbyte if HPM update shall be used)
- EEPROM for storage of non-volatile data (sensor thresholds, min/max values)

The **NAMC-MMC-REF** features an Atmel AVRxmega128A4U as IPMI-Microcontroller. All pins of the microcontroller are accessible via pin headers for e.g. measuring purpose. For detailed information about the pin assignment, refer to chapter 4.2.3.

The IPMI-Controller manages the geographical address as requested by the AMC specification

Please note: The used device is also available in a more compact QFN package.

3.2 I²C-Devices

The IPMI-Controller connects to several internal I²C-Devices. Please note that the 7-bit I²C-Address is left aligned in the notation below, meaning that in the most-right bit (LSB) the I²C R/W bit resides.

- LM95241 – Temperature sensor – I²C-Address: 0x56
- MAX6604 – Temperature Sensor – I²C-Address: 0x30
- LM75 – Temperature Sensor – I²C-Address: 0x90
- LTC4215 – Hot Swap Controller – I²C-Address: 0x96
- PDT006A0X – DC/DC-Converter 12V → 3.3V – I²C-Address: 0xFE

Additionally, the IPMB-Bus of the AMC connector is attached to the IPMI-Controller (IPMI_SDA and IPMI_SCL).

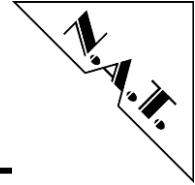

3.3 Sensors

The **NAMC-MMC-REF** is equipped with two kinds of sensors.

3.3.1 Temperature Sensors

The IPMI specification predicts to have at least two temperature sensors. These can be implemented by nearly any I²C based temperature sensor chip, connected to the microcontroller by a local I²C bus. The reference design is showing different temperature sensors (U4-6). Any of these are supported by the **NAMC-MMC-REF**. The sensor that fits best to the target application may be chosen (not all!).

The LM95241 (U4) can measure 3 temperatures. Therefore a single LM95241 on an AMC is sufficient. If the MAX6604 or the LM75 is preferred, two devices are required. An AVRxmega internal temperature sensor implementation may be used as well. Any other implementation e.g. using a PTC connected to one of the ADC inputs is also possible.

3.3.2 Voltage Sensors

There are 8 voltage sensors shown in the reference design to monitor any possible onboard power supply circuitry. It is up to the user to decide which one he finds suitable for his particular design.

Appropriate resistor voltage dividers must be set up to make a voltage to be monitored fit within the full scale range (0V – 1.0V) of the microcontroller ADC. Implementation of at least the sensors for +3.3V_MP and +12V is recommended.

3.4 Hot-Swap-Circuitry

The **NAMC-MMC-REF** is equipped with a Hot-Swap-Circuitry based on a Linear Technology LTC4215 Hot-Swap-Controller. This circuitry shown in the reference design is only optional; it is neither required by the AMC specification nor necessary to run the **NAMC-MMC-REF** software.

3.5 DC/DC-Converter

The **NAMC-MMC-REF** features a 12V-to-3.3V-DC/DC-Converter which is accessible via I²C.

It can be used for evaluating manageable DC/DC converters and in addition its output voltage can be used to supply any test circuitry a user might add to the **NAMC-MMC-REF** board.

3.6 Serial Interface

The RS232 interface is physically represented by a Mini-USB-Jack on the front plate and can be used for debugging purpose.

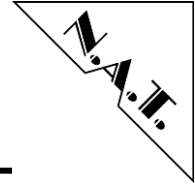

4 Hardware

4.1 Front Panel and LED

The **NAMC-MMC-REF** module contains the standard AMC LEDs consisting of a red Fault Indication LED and a blue Hot-Swap indication LED, both controlled by the IPMI controller.

The Fault Indication LED turns to “On” during HPM update to indicate that the board should not be powered off during the flashing process to prevent bricking the firmware.

Although optically appearing as one LED, the General Purpose LED (Stat) physically consists of two LEDs (green and orange) sharing the same hole in the Front Plate. It is controlled by board logic from the payload block. On the **NAMC-MMC-REF** module, the status LED can be controlled by the microcontroller as well, if the correspondent connection on the pin header is closed. **Refer to Table 5: JP3: Microcontroller Port Pins – Pin Assignment** for details.

If using the MMC-REF-PIGGY board on the NAMC-MMC-REF the header cannot be accessed by a jumper. In this case the following connections should be made with a soldering iron. Refer to Figure 4. **NOTE: Soldering on hardware may void guarantee.**

- JP3 (Pin1 to Pin2)
- JP3 (Pin3 to Pin4)

Figure 4: Notes for soldering LED connections

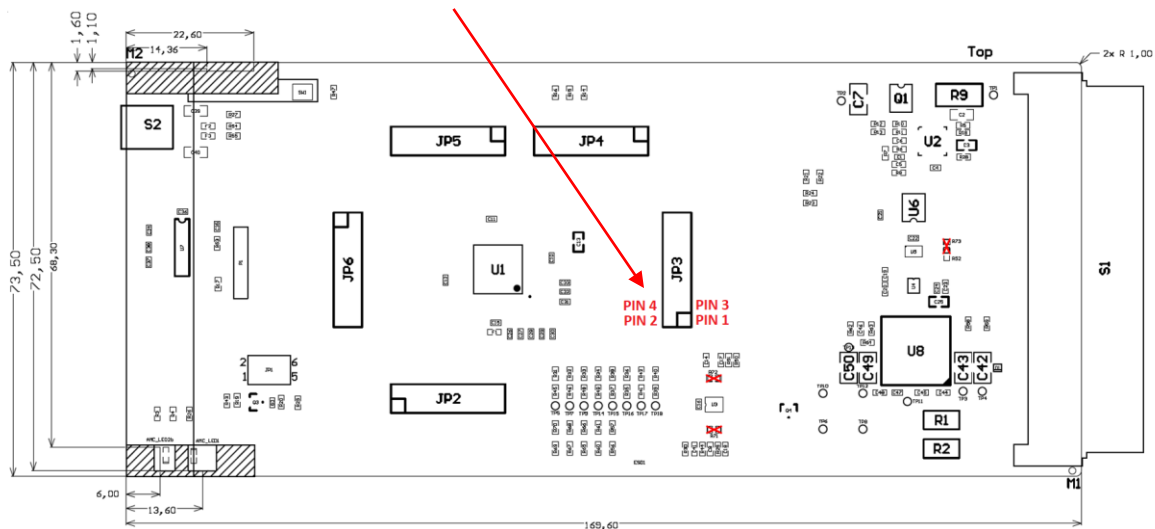

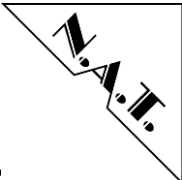
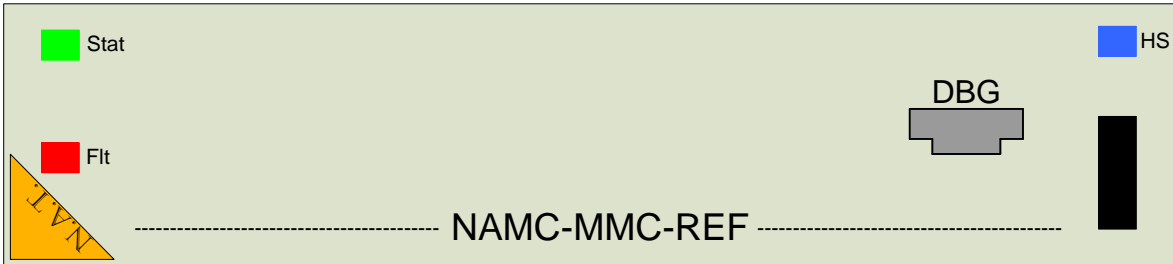
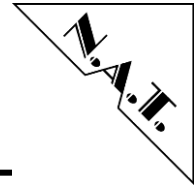

Figure 5: Front Panel





4.2 Connectors and Switches

Figure 6: Connector and Switch Location – Overview

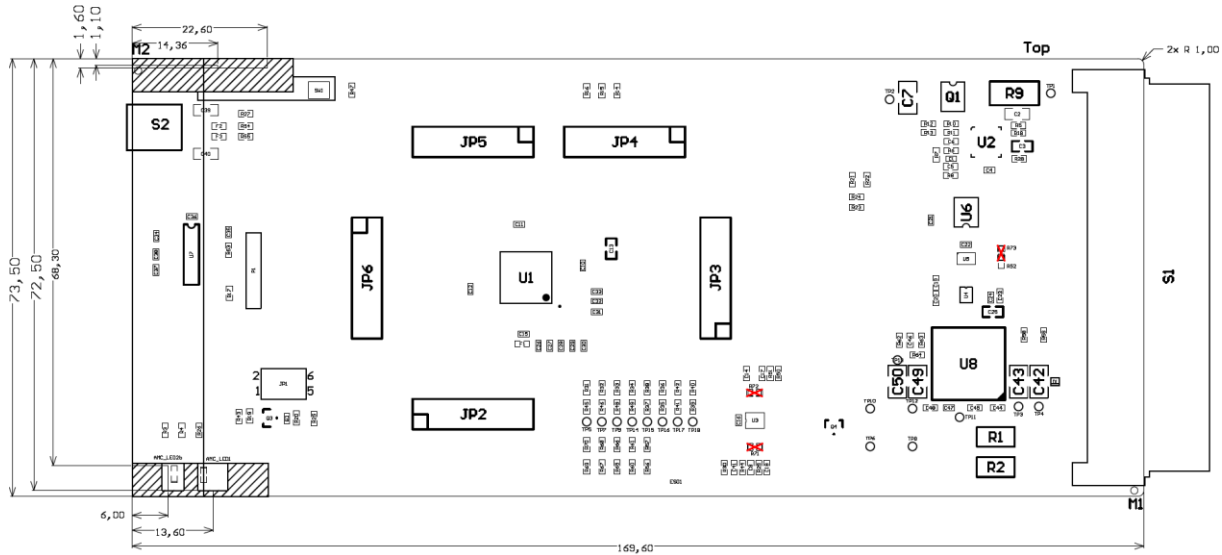

Please refer to the following tables to look up the connector pin assignment of the **NAMC-MMC-REF**.

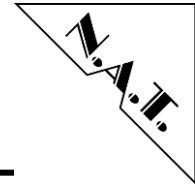

4.2.1 CON1: AMC Connector

Table 2: AMC Connector – Pin Assignment

Pin #	AMC-Signal	AMC-Signal	Pin #
1	GND	GND	170
2	PWR	TDI	169
3	/PS1	TDO	168
4	PWR_IPMB	/TRST	167
5	GA0	TMS	166
6	RESVD	TCK	165
7	GND	GND	164
8	RESVD	NC	163
9	PWR	NC	162
10	GND	GND	161
11	PORT0_TX_P	NC	160
12	PORT0_TX_N	NC	159
13	GND	GND	158
14	PORT0_RX_P	NC	157
15	PORT0_RX_N	NC	156
16	GND	GND	155
17	GA1	NC	154
18	PWR	NC	153
19	GND	GND	152
20	PORT1_TX_P	NC	151
21	PORT1_TX_N	NC	150
22	GND	GND	149
23	PORT1_RX_P	NC	148
24	PORT1_RX_N	NC	147
25	GND	GND	146
26	GA2	NC	145
27	PWR	NC	144
28	GND	GND	143
29	NC	NC	142
30	NC	NC	141
31	GND	GND	140
32	NC	TCLKD_P	139
33	NC	TCLKD_N	138
34	GND	GND	137
35	NC	TCLKC_P	136
36	NC	TCLKC_N	135
37	GND	GND	134
38	NC	NC	133
39	NC	NC	132
40	GND	GND	131
41	/ENABLE	NC	130
42	PWR	NC	129
43	GND	GND	128
44	PORT4_TX_P	RESVD	127

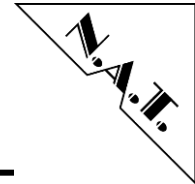

Pin #	AMC-Signal	AMC-Signal	Pin #
45	PORT4_TX_N	TDM_REF	126
46	GND	GND	125
47	PORT4_RX_P	TDM_FS	124
48	PORT4_RX_N	TDM_CLK	123
49	GND	GND	122
50	PORT5_TX_P	TDM7	121
51	PORT5_TX_N	TDM6	120
52	GND	GND	119
53	PORT5_RX_P	TDM5	118
54	PORT5_RX_N	TDM4	117
55	GND	GND	116
56	IPMB_SCL	TDM3	115
57	PWR	TDM2	114
58	GND	GND	113
59	PORT6_TX_P	TDM1	112
60	PORT6_TX_N	TDM0	111
61	GND	GND	110
62	PORT6_RX_P	PORT11_TX_P	109
63	PORT6_RX_N	PORT11_TX_N	108
64	GND	GND	107
65	PORT7_TX_P	PORT11_RX_P	106
66	PORT7_TX_N	PORT11_RX_N	105
67	GND	GND	104
68	PORT7_RX_P	PORT10_TX_P	103
69	PORT7_RX_N	PORT10_TX_N	102
70	GND	GND	101
71	IPMB_SDA	PORT10_RX_P	100
72	PWR	PORT10_RX_N	99
73	GND	GND	98
74	TCLKA_P	PORT9_TX_P	97
75	TCLKA_N	PORT9_TX_N	96
76	GND	GND	95
77	TCLKB_P	PORT9_RX_P	94
78	TCLKB_N	PORT9_RX_N	93
79	GND	GND	92
80	FCLKA_P	PORT8_TX_P	91
81	FCLKA_N	PORT8_TX_N	90
82	GND	GND	89
83	/PS0	PORT8_RX_P	88
84	PWR	PORT8_RX_N	87
85	GND	GND	86

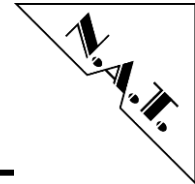

4.2.2 JP1: Microcontroller Programming Header

JP1 connects to the programming port of the Atmel microcontroller.

Table 3: JP1: Microcontroller Programming Header – Pin Assignment

Pin #	Signal	Signal	Pin #
1	PDI_Data	+3.3V_MP	2
3	nc	N_PROG	4
5	PDI_CLK	GND	6

4.2.3 JP2 – JP6: Microcontroller Port Pins

All pins of the Atmel microcontroller are routed to the pin headers JP2 to JP6 for measuring purposes.

Table 4: JP2: Microcontroller Port Pins – Pin Assignment

Pin #	Signal	Signal	Pin #
1	1.0V_SENSE	GND	2
3	1.2V_SENSE	GND	4
5	1.5V_SENSE	GND	6
7	1.8V_SENSE	GND	8
9	2.5V_SENSE	GND	10
11	3.3V_SENSE	GND	12
13	MP_SENSE	GND	14
15	12V_SENSE	GND	16

Table 5: JP3: Microcontroller Port Pins – Pin Assignment

Pin #	Signal	Signal	Pin #
1	PB0	LED2a	2
3	PB1	LED2b	4
5	PB2	GND	6
7	/ALERT	GND	8
9	+3.3V_PP	GND	10
11	+3.3V_PP	GND	12
13	+3.3V_PP	GND	14
15	+3.3V_MP	GND	16

Table 6: JP4: Microcontroller Port Pins – Pin Assignment

Pin #	Signal	Signal	Pin #
1	ISDA	GND	2
3	ISCL	GND	4
5	/BLUE_LED	GND	6
7	/LED1	GND	8
9	AMC_GA0	GND	10
11	AMC_GA1	GND	12
13	AMC_GA2	GND	14
15	GA_PULLUP	GND	16

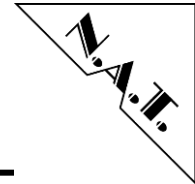

Table 7: JP5: Microcontroller Port Pins – Pin Assignment

Pin #	Signal	Signal	Pin #
1	PD0	GND	2
3	PD1	GND	4
5	PD2	GND	6
7	PD3	GND	8
9	PD4	GND	10
11	PD5	GND	12
13	PD6	GND	14
15	PD7	GND	16

Table 8: JP6: Microcontroller Port Pins – Pin Assignment

Pin #	Signal	Signal	Pin #
1	SDA_INT	GND	2
3	SCL_INT	GND	4
5	RXD	GND	6
7	TXD	GND	8
9	+3.3V_MP	GND	10
11	+3.3V_PP	GND	12
13	/HS_SW	GND	14
15	PWRGD_HS	GND	16

4.2.4 S2: USB Connector

Connector S2 offers access to the microcontroller’s USB interface.

Table 9: S2: USB Connector – Pin Assignment

Pin #	Signal	Signal	Pin #
1	nc	RxDA	2
3	TxDA	nc	4
5	GND	SGND	6
7	SGND	SGND	8
9	SGND		

4.2.5 SW1: Hot Swap Switch

Switch SW1 is used to support Hot-Swapping of the module. It conforms to PICMG AMC.0.

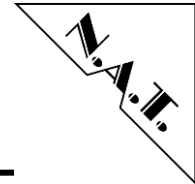

5 Board Specification

Table 10: NAMC-MMC-REF Specification – Overview

Microcontroller	Atmel AVRxmega128A4U
AMC-Module	Standard Advanced Mezzanine Card, mid-size, single width
Front-I/O	RS232 (Mini-USB)
Power Consumption	12V, 0.2A max.
Operating Temperature	0°C – +55°C with forced cooling
Storage Temperature	-40°C - +85°C
Humidity	10% – 90% rh non-condensing
Standards compliance	PICMG AMC.0 Rev. 2.0 IPMI Specification v2.0 Rev. 1.0 PICMG μ TCA.0 Rev. 1.0

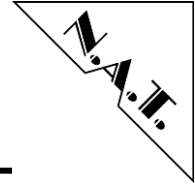

6 Installation

6.1 Safety Note

To ensure proper functioning of the **NAMC-MMC-REF** during its usual lifetime take the following precautions before handling the board.

CAUTION

Electrostatic discharge and incorrect board installation and uninstallation can damage circuits or shorten their lifetime.

- Before installing or uninstalling the **NAMC-MMC-REF** read this installation section.
- Before installing or uninstalling the **NAMC-MMC-REF**, read the Installation Guide and the User's Manual of the carrier board used or of the μ TCA system the board will be plugged into.
- Before installing or uninstalling the **NAMC-MMC-REF** on a carrier board or both in a rack:
 - Check all installed boards and modules for steps that you have to take before turning on or off the power.
 - Take those steps.
 - Finally turn on or off the power if necessary.
 - Make sure the part to be installed / removed is Hot-Swap capable, if you don't switch off the power.
- Before touching integrated circuits ensure to take all required precautions for handling electrostatic devices.
- Ensure that the **NAMC-MMC-REF** is connected to the carrier board or to the μ TCA backplane with the connector completely inserted.
- When operating the board in areas of strong electromagnetic radiation ensure that the module
 - is bolted the front panel or rack
 - and shielded by closed housing

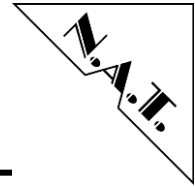

6.2 Installation Prerequisites and Requirements

IMPORTANT

Before powering up check this section for installation prerequisites and requirements!

6.2.1 Requirements

The installation requires only:

- an ATCA carrier board or a μ TCA backplane for connecting the **NAMC-MMC-REF**
- power supply
- cooling devices

6.2.2 Power supply

The power supply for the **NAMC-MMC-REF** must meet the following specifications:

- required for the module: +12V / 0.2A max.

6.2.3 Automatic Power Up

In the following situations the **NAMC-MMC-REF** will automatically be reset and proceed with a normal power up:

- The voltage sensor generates a reset
 - when +12V voltage level drops below 10V
 - when +3.3V voltage level drops below 3.08V
- when the carrier board / backplane signals a Reset.

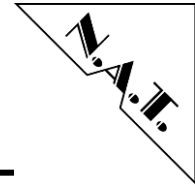

6.3 Statement on Environmental Protection

6.3.1 Compliance to RoHS Directive

Directive 2011/65/EU of the European Parliament and of the Council of 8 June 2011 on the "Restriction of the use of certain Hazardous Substances in Electrical and Electronic Equipment" (RoHS) predicts that all electrical and electronic equipment being put on the European market after June 30th, 2006 must contain lead, mercury, hexavalent chromium, polybrominated biphenyls (PBB) and polybrominated diphenyl ethers (PBDE) and cadmium in maximum concentration values of 0.1% respective 0.01% by weight in homogenous materials only.

As these hazardous substances are currently used with semiconductors, plastics (i.e. semiconductor packages, connectors) and soldering tin any hardware product is affected by the RoHS directive if it does not belong to one of the groups of products exempted from the RoHS directive.

Although many of hardware products of N.A.T. are exempted from the RoHS directive it is a declared policy of N.A.T. to provide all products fully compliant to the RoHS directive as soon as possible. For this purpose since January 31st, 2005 N.A.T. is requesting RoHS compliant deliveries from its suppliers. Special attention and care has been paid to the production cycle, so that wherever and whenever possible RoHS components are used with N.A.T. hardware products already.

6.3.2 Compliance to WEEE Directive

Directive 2002/95/EC of the European Commission on "Waste Electrical and Electronic Equipment" (WEEE) predicts that every manufacturer of electrical and electronic equipment which is put on the European market has to contribute to the reuse, recycling and other forms of recovery of such waste so as to reduce disposal. Moreover this directive refers to the Directive 2002/95/EC of the European Commission on the "Restriction of the use of certain Hazardous Substances in Electrical and Electronic Equipment" (RoHS).

Having its main focus on private persons and households using such electrical and electronic equipment the directive also affects business-to-business relationships. The directive is quite restrictive on how such waste of private persons and households has to be handled by the supplier/manufacturer; however, it allows a greater flexibility in business-to-business relationships. This pays tribute to the fact with industrial use electrical and electronic products are commonly integrated into larger and more complex environments or systems that cannot easily be split up again when it comes to their disposal at the end of their life cycles.

As N.A.T. products are solely sold to industrial customers, by special arrangement at time of purchase the customer agreed to take the responsibility for a WEEE compliant disposal of the used N.A.T. product. Moreover, all N.A.T. products are marked according to the directive with a crossed out bin to indicate that these products within the European Community must not be disposed with regular waste.

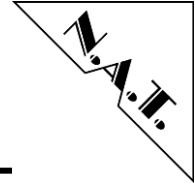

If you have any questions on the policy of N.A.T. regarding the Directive 2011/65/EU of the European Parliament and of the Council of 8 June 2011 on the "Restriction of the use of certain Hazardous Substances in Electrical and Electronic Equipment" (RoHS) or the Directive 2002/95/EC of the European Commission on "Waste Electrical and Electronic Equipment" (WEEE) please contact N.A.T. by phone or e-mail.

6.3.3 Compliance to CE Directive

Compliance to the CE directive is declared. A 'CE' sign can be found on the PCB.

6.3.4 Product Safety

The board complies with EN60950 and UL1950.

6.3.5 Compliance to REACH

The REACH EU regulation (Regulation (EC) No 1907/2006) is known to N.A.T. GmbH. N.A.T. did not receive information from their European suppliers of substances of very high concern of the ECHA candidate list. Article 7(2) of REACH is notable as no substances are intentionally being released by NAT products and as no hazardous substances are contained. Information remains in effect or will be otherwise stated immediately to our customers.

7 Piggy Board

This section is only for modules containing the NAMC-MMC-REF-PIGGY.

The NAMC-MMC-REF-PIGGY Board was designed for the baseboard in order to enable developers to evaluate uRTM functionality as defined in PIGMG MicroTCA.4 specification using a standard full size single width AMC module. The PIGGY board is mounted on the top side pin header of the NAMC-MMC-REF baseboard. Due to of the mid-size front panel height restrictions the baseboard uses a full-size front panel to serve space for the user IO an LED breakthrough.

Figure 7: NAMC-MMC-REF with piggy board

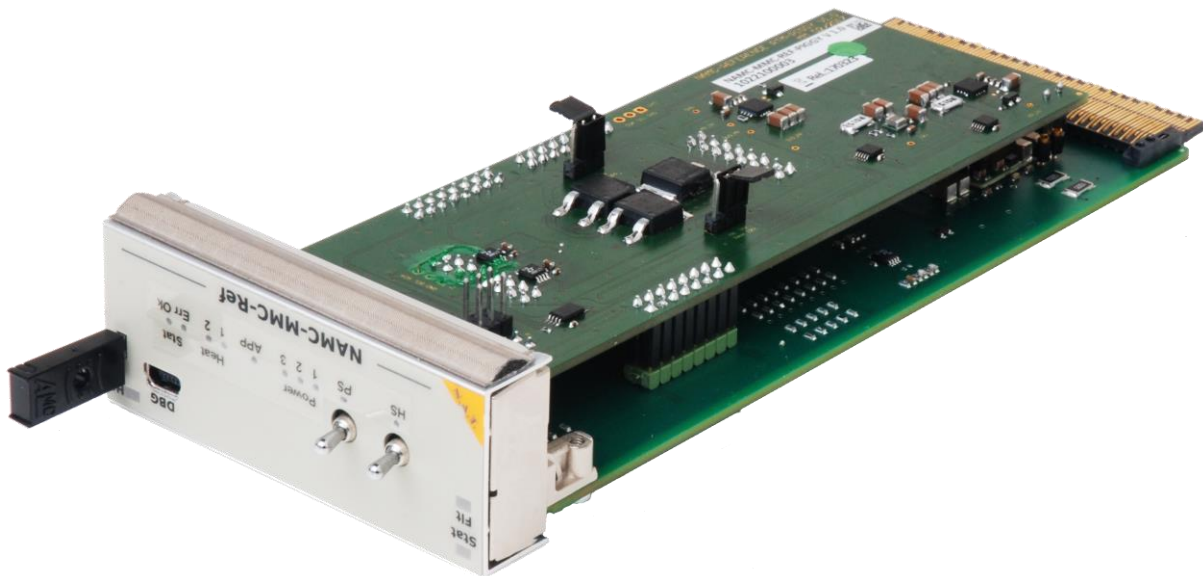

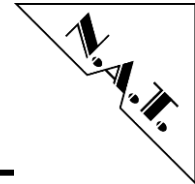

Basically the board consists out of the mandatory management circuit that is defined in MicroTCA.4 specification. The picture below shows the minimum hardware that is required for an uRTM. The complete schematics of the board can be found in the document attachments.

Figure 8: AMC/uRTM Management Block Diagram [6]

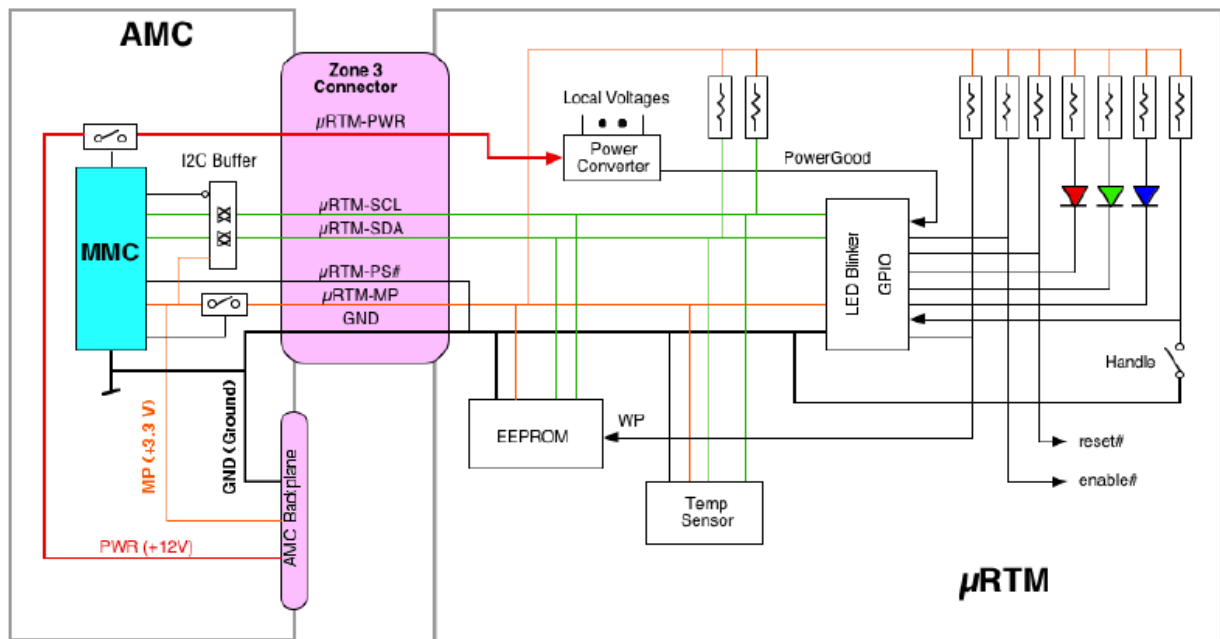

7.1 Hardware Description

On top of the minimum required management circuit the board has the following features:

- Two INA226 sensors for current and voltage
- Heating resistors for generating temperature. Can be switched off or on with jumper setting on board (J2 and J3)
- Application LED (Dual color)
- Switches for triggering #PS and hotswap handle signals accessible from the AMC front plate

The assembly drawings (top and bottom drawings) are shown in the figures below.

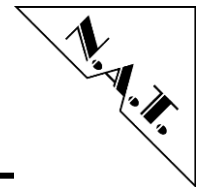

Figure 9: Piggy assembly drawing TOP side

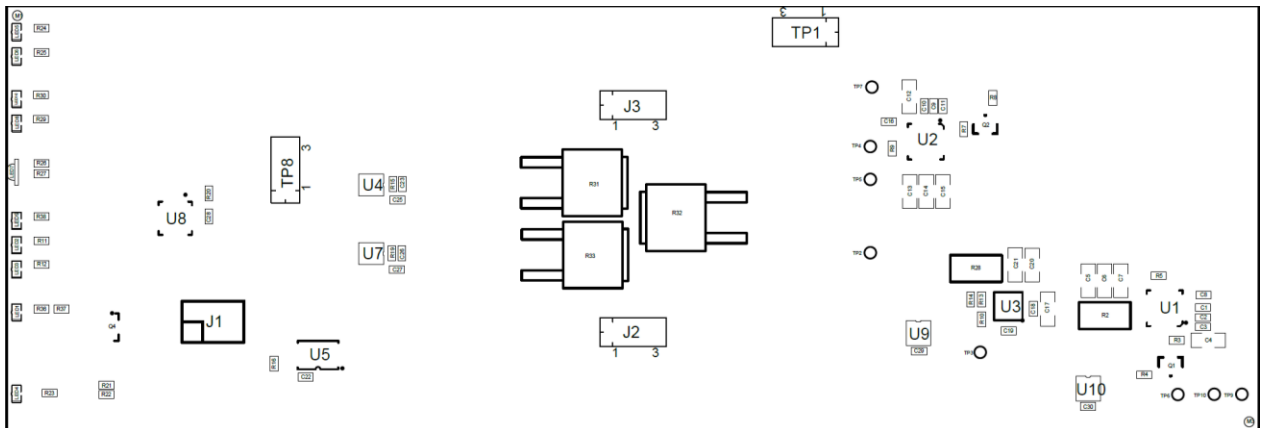

Figure 10: Piggy assembly drawing BOT side

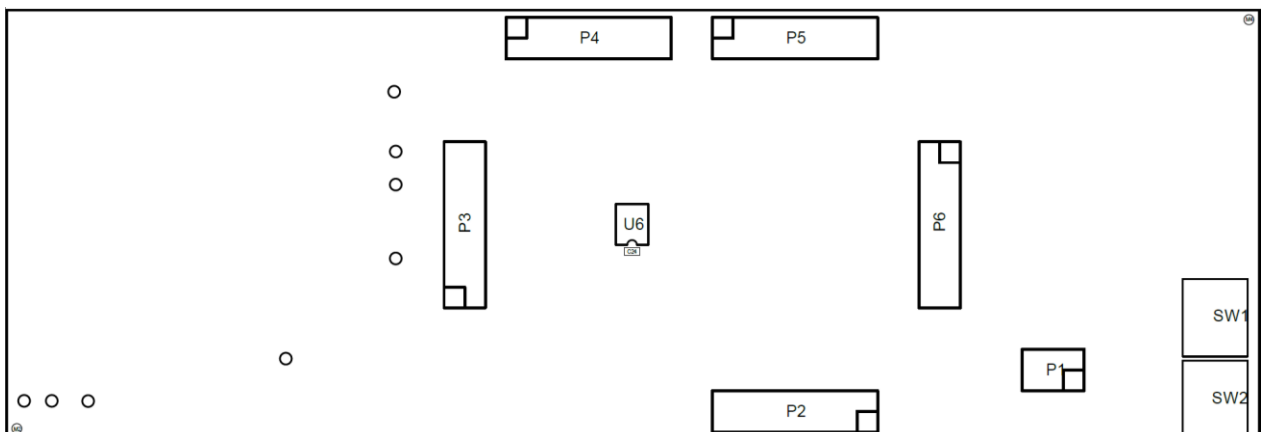
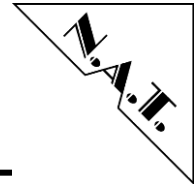

Table 11 shows a list of I2C programmable devices mounted on the piggy board. When talking to these components ensure that the corresponding power is present. A i2c buffer is used (LTC4300A, U7 and U4) to isolate the i2c bus from different power domains (Management Power and Payload Power) avoiding bus blocking if a power domain on a single side goes off.

Table 11: I2C Device List

Component	Name	7 Bit Address		Power Domain
U5	AT24C32D, EEPROM	0x50	101 0000	Management Power
U6	LM75, Temp Sensor	0x49	100 1001	Payload Power
U8	PCAL9539, IO Expander	0x74	111 0100	Management Power
U9	INA226, Current and Voltage Senosr	0x41	100 0001	Payload Power
U10	INA226, Current and Voltage	0x44	100 0100	Management Power



7.2 Front Panel

The user I/O of the piggy board is accessible through the base board full size front panel cut offs. It is shown at the figure below:

Figure 11: Front panel including piggy I/O

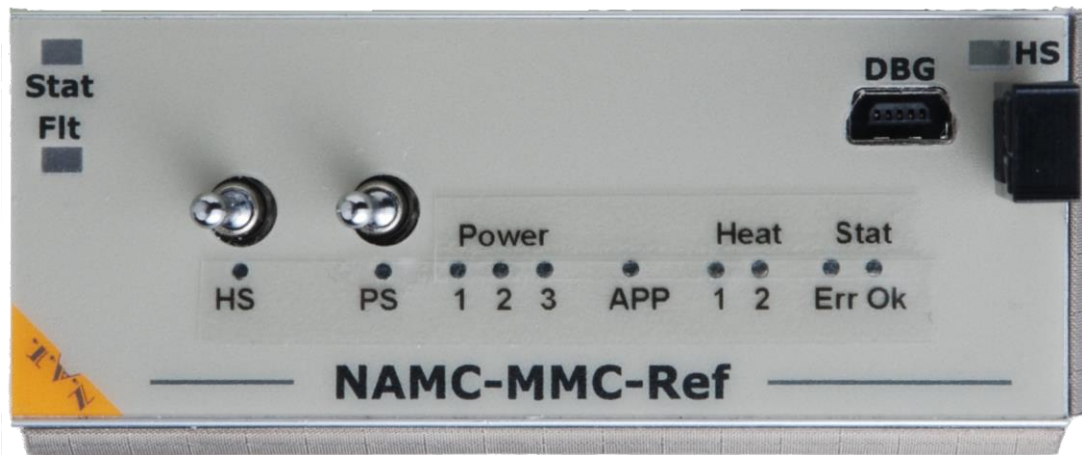

Table 12: Switch description

SW	Function
SW2 (left)	Hot swap handle for uRTM
SW1 (right)	Present signal for uRTM

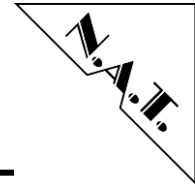
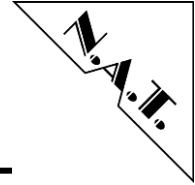

Table 13: LED description

LED	Function
LED Blue (HS)	Hot Swap LED ON: Hot Swap Open State OFF: Hot Swap Closed State
LED PS	PS switch state LED ON: #PS is low (Module is present, LED off) OFF: #PS is high (Module is absent, LED on)
LED Stat Ok	Status LED (Green) ON: No errors OFF: TBD Blink: Front AMC is in State M4
LED Stat Err	Status LED (Red) ON: Error OFF: No error
LED Heat 1	Heat LED for 3.3V Payload Power ON: 3V3_PP heating on OFF: 3V3_PP heating off
LED Heat 2	Heat LED for 12V Payload Power ON: 12V heating on OFF: 12V heating off
LED Power 1	3.3V Management Power LED ON: 3V3_MP power on OFF: 3V3_MP power off
LED Power 2	3.3V Payload Power LED ON: 3V3_PP power on OFF: 3V3_PP power off
LED Power 3	12V Payload Power LED ON: 12V power on OFF: 12V power off
LED APP	Dual color (Red/Green) application defined LED. Per default, this LED performs a blink show switching color from red to green each second.

7.3 Heat Resistors

The piggy board contains heat resistors that can be switched off and on using jumpers J2 and J3 to produce heat on the board to make the temperature sensor generating temperature events. Ensure proper cooling of the chassis. The reference code includes a security shutdown if temperature gets too hot.



7.4 Programming the baseboard

Programming the baseboard can be performed using connector J1. It gives 1:1 access to the baseboard's 6 Pin Atmel PDI interface.

8 Known Bugs / Restrictions

none

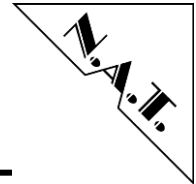

Appendix A: Reference Documentation

- [1] Atmel, AVRxmega128A4U Data Sheet, Rev. 8387G-AVR-03/2014
- [2] Texas Instruments, LM95241 Dual Remote Diode Temp Sensor (Rev. E) – 3/2013
- [3] Maxim, MAX6604 Precision Temperature Monitor – 10/2011
- [4] Texas Instruments, LM75B Digital Temperature Sensor (Rev. B) – 03/2013
- [5] Linear Technologies, LTC4215 Hot-Swap Controller Rev.E
- [6] PIGMC MicroTCA.4 Enhancements for Rear I/O and Timing (Rev 2011)

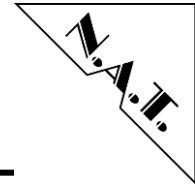

Appendix B: Document's History

Revision	Date	Description	Author
1.0	23.10.2013	initial release	Se
	08.09.2014	Reworked Table 1: Abbreviation List Update Chapter 4.1 LED description Update Chapter 6.3 RoHS-Directive / REACH Update Appendix A: Reference Documentation Added Figure 2: Block Diagram Added Figure 1: Picture	se
1.1	22.02.17	Changed HW version to 2.0	MM
1.2	31.03.17	Added HW description for piggy module	MM
1.3	15.06.20	Rework of LED chapter	MM