

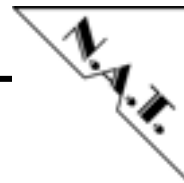

**NAMC-psTimer
Picosecond Timing AMC Module
Installation and Configuration
Manual V1.0**



The NAMC-psTimer has been originally designed by:

Desy Hamburg / University of Stockholm

and optimized and manufactured by:

**N.A.T. GmbH
Konrad-Zuse-Platz 9
53227 Bonn-Oberkassel**

Phone: +49 / 228 / 96 58 64 – 0

Fax: +49 / 228 / 96 58 64 – 10

Internet: <http://www.nateurope.com>



Disclaimer

The following documentation, compiled by N.A.T. GmbH (henceforth called N.A.T.), represents the current status of the product's development. The documentation is updated on a regular basis. Any changes which might ensue, including those necessitated by updated specifications, are considered in the latest version of this documentation. N.A.T. is under no obligation to notify any person, organization, or institution of such changes or to make these changes public in any other way.

We must caution you, that this publication could include technical inaccuracies or typographical errors.

N.A.T. offers no warranty, either expressed or implied, for the contents of this documentation or for the product described therein, including but not limited to the warranties of merchantability or the fitness of the product for any specific purpose.

In no event will N.A.T. be liable for any loss of data or for errors in data utilization or processing resulting from the use of this product or the documentation. In particular, N.A.T. will not be responsible for any direct or indirect damages (including lost profits, lost savings, delays or interruptions in the flow of business activities, including but not limited to, special, incidental, consequential, or other similar damages) arising out of the use of or inability to use this product or the associated documentation, even if N.A.T. or any authorized N.A.T. representative has been advised of the possibility of such damages.

The use of registered names, trademarks, etc. in this publication does not imply, even in the absence of a specific statement, that such names are exempt from the relevant protective laws and regulations (patent laws, trade mark laws, etc.) and therefore free for general use. In no case does N.A.T. guarantee that the information given in this documentation is free of such third-party rights.

Neither this documentation nor any part thereof may be copied, translated, or reduced to any electronic medium or machine form without the prior written consent from N.A.T. GmbH.

This product (and the associated documentation) is governed by the N.A.T. General Conditions and Terms of Delivery and Payment.

Note:

The release of the Installation and Configuration Manual is related to a certain HW board and SW revision given in the document title. For HW and SW revisions earlier than the one given in the document title please contact N.A.T. for the corresponding older Manual release.

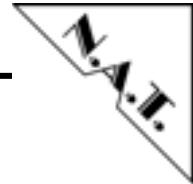
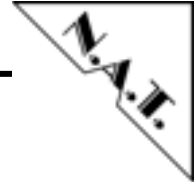

Table of Contents

TABLE OF CONTENTS	4
LIST OF TABLES.....	5
LIST OF FIGURES.....	5
CONVENTIONS.....	6
1. INTRODUCTION	7
1.1.NAMC-PSTIMER - HARDWARE DESCRIPTION	7
2. OVERVIEW	8
2.1.MAJOR FEATURES	8
2.2.BLOCK DIAGRAM	9
2.3. MAIN CLOCK SIGNAL	11
2.4.FRONT CONNECTOR	11
2.4.1. SFP Connectors	11
2.4.2. Special Input/Output connector	12
2.4.3. Clk1, Clk2, Clk3 Trigger output connectors	12
2.4.4. AMC backplane connector	13
2.4.5. Rear Transition Module connector.....	13
3. SOFTWARE INSTALLATION	14
3.1.PREREQUISITES	14
3.2.DOOSCS ENVIRONMENT AND DRIVER INSTALLATION	15
4. CONFIGURATION	16
4.1.JDDD	16
4.2.WATCHDOG SETUP	16
4.3.NAMC-PS-TIMER CONFIGURATION	16
4.3.1. Clock Distribution	17
4.3.2. Trigger Output Configuration	18
4.3.3. Expert Tab	20
4.3.4. Chapters planned for future manual revisions	20
5. HARDWARE	21
5.1.AMC PORT DEFINITION (NEEDS TO BE REVIEWED)	21
5.2.FRONT PANEL AND LEDS	23
5.3.CONNECTOR	24
S1: AMC Connector (needs to reviewed and corrected)	24
6. BOARD SPECIFICATION	28
6.1.BOARD SPECIFICATION (NEEDS TO REVIEWED)	28
7. HARDWARE INSTALLATION	29
7.1.SAFETY NOTE	29
7.2. INSTALLATION PREREQUISITES AND REQUIREMENTS	30
7.2.1. Requirements.....	30
7.2.2. Power supply.....	30
7.2.3. Automatic Power Up.....	30
7.3.STATEMENT ON ENVIRONMENTAL PROTECTION	31
7.3.1. Compliance to RoHS Directive.....	31
7.3.2. Compliance to WEEE Directive	31



7.3.3. Compliance to CE Directive	32
7.3.4. Product Safety.....	32
7.3.5. Compliance to REACH	32
8. KNOWN BUGS / RESTRICTIONS.....	33
APPENDIX A: REFERENCE DOCUMENTATION	34
APPENDIX B: DOCUMENT’S HISTORY.....	35

List of Tables

1. List of used abbreviations	6
2. AMC Port Mapping Strategy	21
3. S1: AMC Connector – Pin-Assignment	24
4. NAMC-psTimer Specification – Overview.....	28

List of Figures

1. NAMC-psTimer – Block Diagram – Overview	9
2. NAMC-psTimer Front Panel	11
3. Special I/O RJ45 Front Connector Pinout.....	12
4. Trigger RJ45 Front Connector Pinout	13
5. NAMC-psTimer Software Interface Diagram.....	14
6. Output Configuration Panel	17
7. Single Channel Configuration Panel	18
8. Output Configuration Expert Panel	19



Conventions

If not otherwise specified, addresses and memory maps are written in hexadecimal notation, identified by 0x.

The following table gives a list of the abbreviations used in this document.

1. List of used abbreviations

Abbreviation	Description
AMC	Advanced Mezzanine Card
ATCA	Advanced Telecommunications Computing Architecture
FCLK	Fabric Clock
FPGA	Field Programmable Gate Array
I ² C	Inter-Integrated Circuit
I/O	Input/Output
IPMB	Intelligent Platform Management Bus
IPMI	Intelligent Platform Management Interface
μTCA	Micro Telecommunications Computing Architecture
MUX	Multiplexing Unit
PCB	Printed Circuit Board
PHY	Physical Layer Device
SerDes	Serializer/Deserializer
SGMII	Serial GMII
SPI	Serial Peripheral Interface
PCIe	PCIexpress



1. Introduction

1.1.NAMC-psTimer - Hardware Description

The NAMC-psTimer is a double width, mid-size AMC board for usage in the MicroTCA.4 architecture. Its main purpose is to output triggers and clock signals which may be based on local Stand-Alone configuration or information provided by a global timing system installation.



2. Overview

2.1. Major Features

- 6 * trigger at front panel
- 3 * clock at front panel
- LVDS signal level / TTL with external hardware
- 8 * trigger at AMC backplane connector
- MLVDS bus to all other AMC boards
- 2 * clock at AMC backplane connector
- Low jitter crosspoint switch at MCH
- 9 * trigger at rear transition module connector
- Rear Transition Module

For detailed description see the following chapter.



2.2. Block Diagram

The following figure shows a block diagram of the **NAMC-psTimer with NAMC-psTimer-P2**.

1. NAMC-psTimer – Block Diagram – Overview

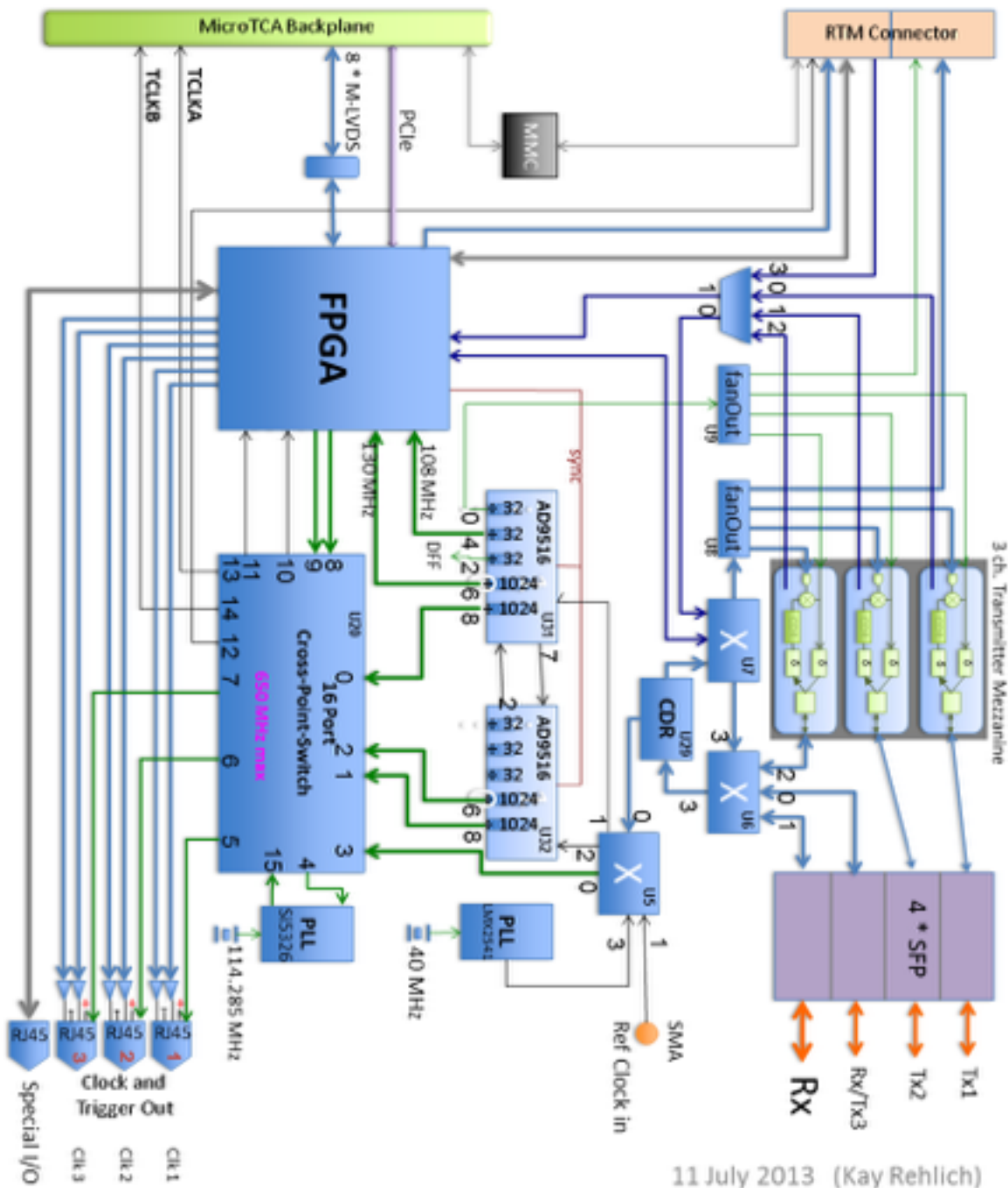





2.3. Main Clock Signal

2.4. Front Connector

The main clock signal (also called 'base frequency'), to which all on-board generated clocks and triggers are phase-stable, may be provided optically from another psTimer-AMC, electrically via a front SMA connector or generated locally via an onboard PLL. The clock frequency has to be between 500MHz and 1.4Ghz¹. If provided electrically by an external clock source, the input voltage must be in range $0V < VIL < 0.8V$ and $0.9V < VIH < 2.5V$.

2. NAMC-psTimer Front Panel

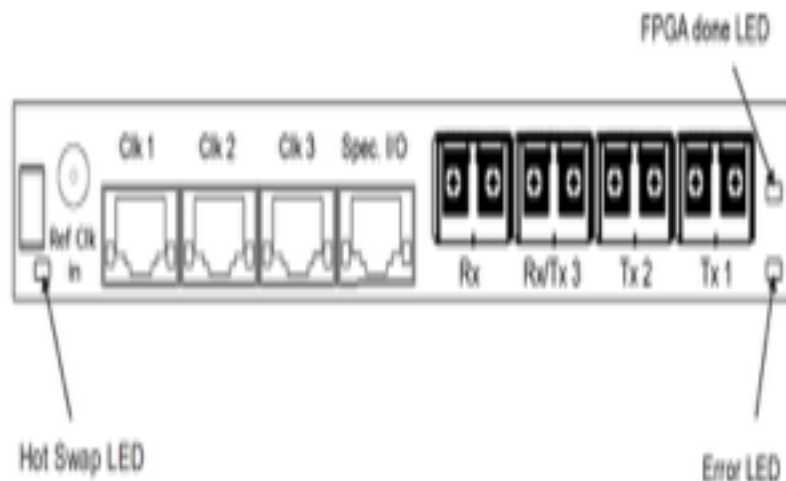

2.4.1. SFP Connectors

The NAMC-psTimer has 4 Small Form-factor Pluggable (SFP) connectors on its front panel. SFP modules with a bandwidth of at least 1.25GBaud are supported. Connector labelled 'Rx' may receive a 500-1.400MHz modulated timing signal from another (master-)psTimer or is unused in stand alone mode. 'Rx/Tx3' labelled connector is configurable either as redundant input (same functionality as 'Rx' connector) or as an output of a 500-1.400MHz modulated timing signal. Both connectors 'Tx3' and 'Tx4' will output a 500-1.400MHz modulated timing signal if a 'piggy-back' or 'daughter-board' is installed on the NAMC-psTimer. Functionality of the DB is described in section ...tbd



2.4.2. Special Input/Output connector

The RJ45 connector labelled ‘Spec. I/O’ on the AMC front panel contains 4 pairs of M-LVDS² signals which are connected to the onboard FPGA. Depending on the FPGA firmware, each pair can be used as input or output independently. With the currently available firmware, all pairs are configured as inputs. They can be used for external trigger inputs and routed directly or combined (AND, OR, Gate) with other triggers to any other trigger output on the front, backplane or RTM. Each pair could also be configured to temporarily inhibit the generation of any trigger output channel. The polarity of any input signal can be inverted in the configuration. An external adapter for converting single-ended TTL signal to LVDS signals is available.

3. Special I/O RJ45 Front Connector Pinout

	Pin	T568A Pair	T568B Pair	Wire	T568A Color	T568B Color	Pin Position
Spec IO 1	1	3	2	tip	white/green stripe	white/orange stripe	8
	2	3	2	ring	green solid	orange solid	7
Spec IO 4	3	2	3	tip	white/orange stripe	white/green stripe	6
	4	1	1	ring	blue solid	blue solid	5
Spec IO 2	5	1	1	tip	white/blue stripe	white/blue stripe	4
	6	2	3	ring	orange solid	green solid	3
Spec IO 4	7	4	4	tip	white/brown stripe	white/brown stripe	2
	8	4	4	ring	brown solid	brown solid	1



2.4.3. Clk1, Clk2, Clk3 Trigger output connectors

Each of the RJ45 connectors labelled ‘Clk1’, ‘Clk2’ and ‘Clk3’ contains a switchable 5 Volt power supply line and 3 pairs of LVDS signals. The first output is a high precision clock line which can be configured to output any frequency that can be generated from the main clock frequency by integer division. The other two output channels can be configured to output delivering any signal generated by the onboard FPGA. Currently triggers, clocks (main clock frequency/24 divided by an integer), bunch pattern (special pattern generated by a master timing system) or any of the Special I/O input signals.

² Multipoint Low Voltage Differential Signal



4. Trigger RJ45 Front Connector Pinout

	Pin	TS66A Pair	TS66B Pair	Wire	TS66A Color	TS66B Color	Pin Position
Clock	1	3	2	tip	white/green stripe	white/orange stripe	8
	2	3	2	ring	green solid	orange solid	5
5 Volt	3	2	3	tip	white/orange stripe	white/green stripe	4
Trigger 1	4	1	1	ring	blue solid	blue solid	3
	5	1	1	tip	white/blue stripe	white/blue stripe	2
GND	6	2	3	ring	orange solid	green solid	1
Trigger 2	7	4	4	tip	white/brown stripe	white/brown stripe	7
	8	4	4	ring	brown solid	brown solid	6



2.4.4. AMC backplane connector

Port 1, 2, 3, 5 - 11, 14, 15, 16 are not connected. Port 0, 4, 12 and 13 are connected to the onboard FPGA high speed interfaces. With the current firmware only Port 4 is used as PCIe communication interface with the host CPU. Port 17 - 20 are connected to the onboard FPGA M-LVDS connections and can be configured as trigger input or output independently. TCLKA/B can output any frequency up to 150 MHz in phase with the main clock.

2.4.5. Rear Transition Module connector

The RTM Zone3 connector contains connections for 9 triggers, high frequency modulated timing signal, PDE programming interface, interrupts and IIC interfaces. For a detailed description please contact DESY or NAT.



3. Software Installation

The following shows the software building blocks of the NAMC-psTimer.

5. NAMC-psTimer Software Interface Diagram

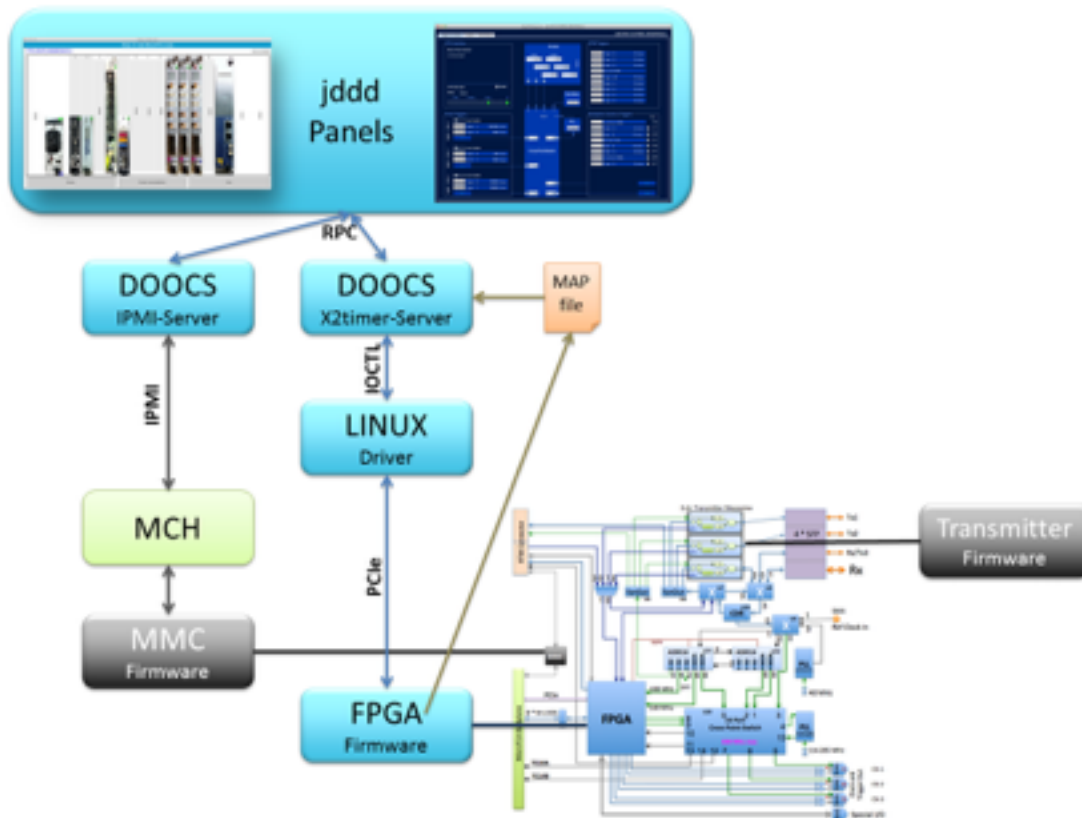

11 July 2013 (Kay Rehlich)

x2timer Block Diagram

3.1. Prerequisites

Before downloading and installing the software environment for using the NAMC-psTimer, please verify that the module has been correctly identified on the PCIe bus. Type `lspci` on the Linux command line and check that a device `xx:yy.z Communication synchronizer: Xilinx Corporation Device 0020` is displayed. If the device is missing in the device list, check that your MCH is configured correctly and look at the troubleshooting section.



3.2.DOOCS Environment and Driver Installation

Currently only a user interface based on DESYS DOOCS environment is available. A basic installation guide can be found online at

<https://ttfinfo.desy.de/DOOCSWiki/Wiki.jsp?page=DOOCSStandaloneInstallation#section-DOOCSStandaloneInstallation-InitialSetupUbuntu>. Follow the instructions up to the point where you edit /export/doocs/server/ENS_auth/ens_server.conf. Add this entry at the bottom of the file:

[Sorry. Ignored \begin{lstlisting} ... \end{lstlisting}]

Restart the ENS server and continue with the instructions. You only need to install x1timer driver with

apt-get install x1timer-dkms and x2timer server with

apt-get install doocs-x2timer-server. When all packages are installed, x2timers[] should be visible in /dev. Open the config file

/export/doocs/server/x2timer_server/x2timer_server.conf and change these lines:

[Sorry. Ignored \begin{lstlisting} ... \end{lstlisting}]

The line `oper_gid` sets the permissions to the x2timer server. The value depends on which users should be able to do any changes to the server configuration. You can get the group id of any users with the command `id` on the command line. This is the same for the watchdog server. If you get a "permission denied" in the jddd-panels later, please change the values in the config file accordingly and restart the servers as described in the only `????` manual. Continue with the installation of Java DOOCS Data Display and the Java Runtime Environment.



4. Configuration

4.1. JDDD

JDDD - or Java DOOCS Data Display - is a graphical Java-based editor for control system panels developed and maintained at Deutsches Elektronen-Synchrotron. With JDDD it is very simple to create your own graphical panels for configuring the NAMC-psTimer or use the panel that are distributed by DESY. The latest version can be downloaded at <http://jddd.desy.de/>. During installation you should already have downloaded JDDD. You can either run it from the web or from a command line with the command `jddd`.

4.2. Watchdog Setup

During installation of the driver and server you already downloaded a package with the most important panels to configure the watchdog server (which will automatically launch the `x2timer_server` after a reboot) and the NAMC-psTimer itself. Choose "File" "Open Local File..." in `jddd` and select

`/usr/share/jddd/panels/global/LocalWatchdogOverview.xml`. Click "Run Active Panel". Scroll down to the entry "SVR.X2TIMER" and click the "control"-button. Click on the "Start and Online"-button and after that the "On"-checkbox in the upper right corner. The watchdog server is now configured to automatically start the `x2timer` server. Close the windows and select "File" "Open Local File..." in `jddd` and select

`/usr/share/jddd/panels/global/timing/x2timer/SlaveTiming.xml`. Before running that panel, enter "TEST.DOOCS/X2TIMER/UBUNTU.0/" in the "adr"-property on the right and press enter. Now run the active panel. Once the psTimer is configured, the same configuration will be loaded to the hardware after a power cycle through the server. If you wish to change the configuration frequently, you can save the panel anywhere in your home directory.

4.3. NAMC-ps-Timer Configuration

In figure 16 an overview of all output channels of the NAMC-psTimer is shown. It is divided into these parts:

- top left: CPU interface - CPU interrupts can be enabled and disable here. Each output channel can generate it's own interrupt at the moment it is triggered. Only one bit should be enabled in the register.
- bottom left: output configuration for each front output (3*RJ45 connector: 2* trigger + 1* low jitter clock per connector). Click the button "FRONT.TRGx" on the left side of a channel to configure the output.
- top right: output configuration for each rear transition module output. Click the button "FRONT.TRGx" on the left side of a channel to configure the output.
- bottom right: output configuration for each AMC connector output. Click the button "FRONT.TRGx" on the left side of a channel to configure the output. Enable the checkbox on the right side to enable the output driver.
- mid top: low jitter clock dividers - Enter the divider ($1.300\text{MHz}/x$) and the delay and mark the according checkbox below to enable the output driver of the divider channel. Only enable one output to reduce noise and crosstalk.



6. Output Configuration Panel

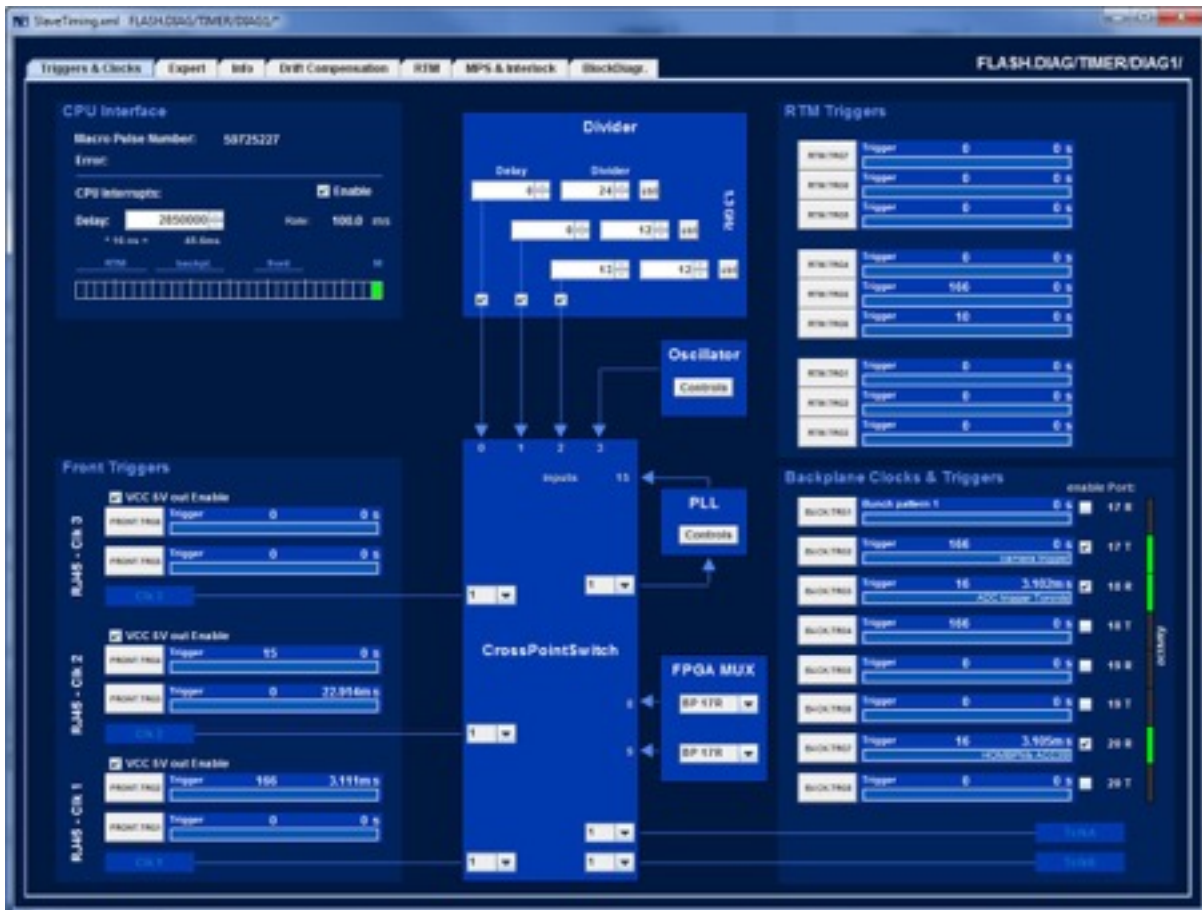

- mid bottom: low jitter crosspoint switch - mark the checkbox and enter the input number for any output channel.

4.3.1. Clock Distribution

In the middle of panel 16 the low-jitter clock distribution is visible. In the upper part, 3 independent dividers are configurable. The input clock to these dividers is the main clock. Each output of the dividers is connected to the low-jitter crosspoint switch which is visible in the lower part. From here, the user can select, where to route the clock signals. They can be output at each RJ45 output connector at the front panel, to an internal PLL to generate different frequencies, or to the TCLKA/B lines at the AMC backplane connector.



4.3.2. Trigger Output Configuration

In figure 18, the configuration panel for one channel is shown. A channel description should be entered in the top row. As input these option can be selected:

- Trigger delayed - a Event generated by the MicroTCA timing master.
- Trigger immediate - an asynchronous Event coming from the old Timing System or from an external input to the MicroTCA timing master.
- Trigger delayed or immediate - Output is triggered both at delayed ot immediate events
- Bunch pattern (1-6) - Output is triggered at occurrence of a bunch pattern which can be masked in the **Fehler! Verweisquelle konnte nicht gefunden werden.** of the Slave Timing Panel.
- FPGA clock (1-3) - FPGA clock configured in **Fehler! Verweisquelle konnte nicht gefunden werden.** will be connected to output

7. Single Channel Configuration Panel



- RJ45 input (1-4) - The signal connected to RJ45 Special I/O connector at the AMC front panel will be output

For more flexibility, each configured channel can be combined with a second channel before it is connected to the RJ45 connector/backplane/RTM. The second channel can be selected in the second drop-down list. Combinations of the two channel can be



- Width output - ignore second source, directly connect channel to output
- Clock 108MHz - ignore both sources, connect 108MHz clock from FPGA to output
- Data 108MHz - ignore both sources, connect 108MHz data link containing timing protocol from FPGA to output
- UART 115k - ignore both sources, connect 115kBit Beckhoff signal from FPGA to output
- Gate - first source channel starts trigger output, second source channel ends trigger output
- 2. Channel - output the same signal that is already configured at some other output channel
- AND 2. channel - both source channels have to be triggered to generate a trigger at the output
- OR 2. channel - either of both source channels may be triggered to generate a trigger at the output
- other (may be used for debug purposes)

In the bottom line the event number on which will be triggered, the local delay, the pulse width of the output signal and a local fine delay can be entered.

8. Output Configuration Expert Panel

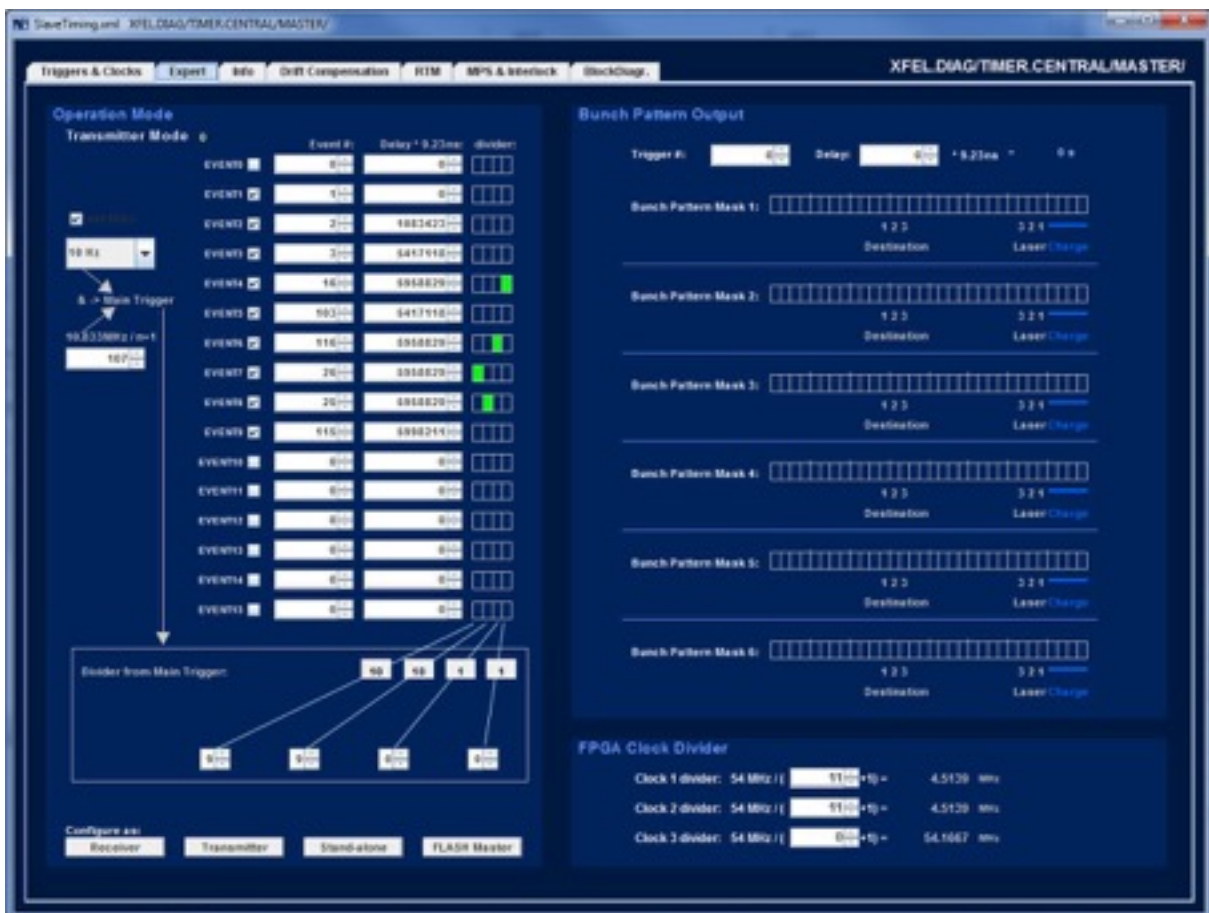



4.3.3. Expert Tab

In figure **Fehler! Verweisquelle konnte nicht gefunden werden.** the advanced configuration of the NAMC-psTimer is shown. It's split into these parts:

- left: Operation mode - Set the configuration mode: Stand-Alone, Transmitter or Receivers
- top right: bunch pattern mask configuration -
- bottom right: FPGA clock divider: FPGA can generate 3 phase stable frequencies, generated from 54,167 MHz. A divider for each clock can be entered here. Each FPGA clock can be connected to any output.

Each x2timer can be configured to run as stand-alone system (using internal PLL to generate main clock), transmitter system (using front SMA connector as main clock) or as receiver (main clock is generated in the timing master). If it is configured as stand-alone or transmitter, events can be configured here. The main repetition rate is selected from a dropdown menu. For each event an integer divider may be configured, so that e.g. one event is output at 10 Hz, another event at 5 Hz and a third event at 2 Hz. If the NAMC-psTimer runs as receiver, events are generated by the timing master and must be configured there.

4.3.4. Chapters planned for future manual revisions

- bunch pattern generation
- firmware update mechanism

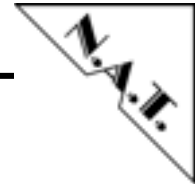

5. Hardware

5.1.AMC Port Definition *(needs to be reviewed)*

2. AMC Port Mapping Strategy

	Port #	AMC Port Mapping Strategy	Ports used as
Basic Connector	CLK1	Clocks	Reference Clock 1 / TCLKA
	CLK2		Reference Clock 2 / TCLKB
	CLK3		Reference Clock 3 / FCLKA
	0	Common Options Region	unassigned
	1		unassigned
	2		unassigned
	3		unassigned
	4	Fat Pipes	PCIe Lane 0
	5		unassigned
	6		unassigned
7	unassigned		
Extended Connector	8	Region	unassigned
	9		unassigned
	10		unassigned
	11		unassigned
	12	Extended Options Region	AMC MLVDS
	13		AMC MLVDS
	14		To be verified unassigned?
	15		To be verified unassigned?
	16		TCLKC / TCLKD
	17		AMC MLVDS
18	AMC MLVDS		
19	AMC MLVDS		
20	AMC MLVDS		





5.2.Front Panel and LEDs

The **NAMC-psTimer** module is equipped with various LED to display an overview real time status of the most important board functions.

A detailed description of these will follow in a later version of this manual.



5.3.Connector

S1: AMC Connector (needs to reviewed and corrected)

3. S1: AMC Connector – Pin-Assignment

Pin #	AMC-Signal	AMC-Signal	Pin #
1	GND	GND	170
2	PWR	TDI	169
3	/PS1	TDO	168
4	PWR_IPMB	/TRST	167
5	GA0	TMS	166
6	RESVD	TCK	165
7	GND	GND	164
8	RESVD	PORT20_TX_P	163
9	PWR	PORT20_TX_N	162
10	GND	GND	161
11	PORT0_TX_P	PORT20_RX_P	160
12	PORT0_TX_N	PORT20_RX_N	159
13	GND	GND	158
14	PORT0_RX_P	PORT19_TX_P	157
15	PORT0_RX_N	PORT19_TX_N	156
16	GND	GND	155
17	GA1	PORT19_RX_P	154
18	PWR	PORT19_RX_N	153
19	GND	GND	152
20	NC	PORT18_TX_P	151
21	NC	PORT18_TX_N	150
22	GND	GND	149
23	NC	PORT18_RX_P	148
24	NC	PORT18_RX_N	147
25	GND	GND	146

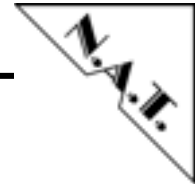

Pin #	AMC-Signal	AMC-Signal	Pin #
26	GA2	PORT17_TX_P	145
27	PWR	PORT17_TX_N	144
28	GND	GND	143
29	NC	PORT17_RX_P	142
30	NC	PORT17_RX_N	141
31	GND	GND	140
32	NC	TCLKD_P	139
33	NC	TCLKD_N	138
34	GND	GND	137
35	NC	TCLKC_P	136
36	NC	TCLKC_N	135
37	GND	GND	134
38	NC	NC	133
39	NC	NC	132
40	GND	GND	131
41	/ENABLE	NC	130
42	PWR	NC	129
43	GND	GND	128
44	PORT4_TX_P	RESVD	127
45	PORT4_TX_N	NC	126
46	GND	GND	125
47	PORT4_RX_P	NC	124
48	PORT4_RX_N	NC	123
49	GND	GND	122
50	NC	PORT13_TX_P	121
51	NC	PORT13_TX_N	120
52	GND	GND	119
53	NC	PORT13_RX_P	118
54	NC	PORT13_RX_N	117
55	GND	GND	116

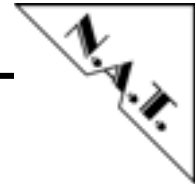

Pin #	AMC-Signal	AMC-Signal	Pin #
56	IPMB_SCL	PORT12_TX_P	115
57	PWR	PORT12_TX_N	114
58	GND	GND	113
59	NC	PORT12_RX_P	112
60	NC	PORT12_RX_N	111
61	GND	GND	110
62	NC	NC	109
63	NC	NC	108
64	GND	GND	107
65	NC	NC	106
66	NC	NC	105
67	GND	GND	104
68	NC	NC	103
69	NC	NC	102
70	GND	GND	101
71	IPMB_SDA	NC	100
72	PWR	NC	99
73	GND	GND	98
74	TCLKA_P	NC	97
75	TCLKA_N	NC	96
76	GND	GND	95
77	TCLKB_P	NC	94
78	TCLKB_N	NC	93
79	GND	GND	92
80	FCLKA_P	NC	91
81	FCLKA_N	NC	90
82	GND	GND	89
83	/PS0	NC	88
84	PWR	NC	87
85	GND	GND	86





6. Board Specification

6.1. Board Specification *(needs to reviewed)*

4. NAMC-psTimer Specification – Overview

AMC-Module	Standard Advanced Mezzanine Card, double width, full-size
Front-I/O	4 RJ45, 4 SPF, 1 SMA
Main Memory	-
FPGA	Spartan-6
Firmware	Desy-Timing-Image
Power Consumption	12V, 4.5A
Operating Temperature	0°C – +55°C with forced cooling
Storage Temperature	-40°C - +85°C
Humidity	10% – 90% rh non-condensing
Standards compliance	PICMG AMC.0 Rev. 2.0 PICMG AMC.2 Rev. 1.0 (Type E2) IPMI Specification v2.0 Rev. 1.0 PICMG µTCA.0 Rev. 1.0



7. Hardware Installation

7.1. Safety Note

To ensure proper functioning of the **NAMC-psTimer** during its usual lifetime take the following precautions before handling the board:

CAUTION

Electrostatic discharge and incorrect board installation and uninstallation can damage circuits or shorten their lifetime!

- Before installing or uninstalling the **NAMC-psTimer** read this installation section
- Before installing or uninstalling the **NAMC-psTimer**, read the Installation Guide and the User's Manual of the carrier board used, or of the uTCA system the board will be plugged into.
- Before installing or uninstalling the **NAMC-psTimer** on a carrier board or both in a rack:
- Check all installed boards and modules for steps that you have to take before turning on or off the power
- Take those steps
- Finally turn on or off the power if necessary
- Make sure the part to be installed / removed is hot swap capable, if you don't switch off the power.
- Before touching integrated circuits ensure to take all require precautions for handling electrostatic devices.
- Ensure that the **NAMC-psTimer** is connected to the carrier board or to the uTCA backplane with the connector completely inserted.
- When operating the board in areas of strong electromagnetic radiation ensure that the module
 - is bolted the front panel or rack
 - and shielded by closed housing



7.2. Installation Prerequisites and Requirements

IMPORTANT

Before powering up check this section for installation prerequisites and requirements!

7.2.1. Requirements

The installation requires only:

1. μ TCA backplane for connecting the **NAMC-psTimer**
2. power supply
3. cooling devices

7.2.2. Power supply

The power supply for the **NAMC-psTimer** must meet the following specifications:

4. required for the module: +12V / 2.5A max.

7.2.3. Automatic Power Up

In the following situations the **NAMC-psTimer** will automatically be reset and proceed with a normal power up:

5. The voltage sensor generates a reset
6. when +12V voltage level drops below 10V
7. when +3.3V voltage level drops below 3.00V
8. The carrier board / backplane signals a PCIe-Reset.

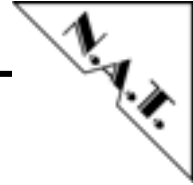

7.3.Statement on Environmental Protection

7.3.1. Compliance to RoHS Directive

Directive 2011/65/EU of the European Parliament and of the Council of 8 June 2011 on the "Restriction of the use of certain Hazardous Substances in Electrical and Electronic Equipment" (RoHS) predicts that all electrical and electronic equipment being put on the European market after June 30th, 2006 must contain lead, mercury, hexavalent chromium, polybrominated biphenyls (PBB) and polybrominated diphenyl ethers (PBDE) and cadmium in maximum concentration values of 0.1% respective 0.01% by weight in homogenous materials only.

As these hazardous substances are currently used with semiconductors, plastics (i.e. semiconductor packages, connectors) and soldering tin any hardware product is affected by the RoHS directive if it does not belong to one of the groups of products exempted from the RoHS directive.

Although many of hardware products of N.A.T. are exempted from the RoHS directive it is a declared policy of N.A.T. to provide all products fully compliant to the RoHS directive as soon as possible. For this purpose since January 31st, 2005 N.A.T. is requesting RoHS compliant deliveries from its suppliers. Special attention and care has been paid to the production cycle, so that wherever and whenever possible RoHS components are used with N.A.T. hardware products already.

7.3.2. Compliance to WEEE Directive

Directive 2002/95/EC of the European Commission on "Waste Electrical and Electronic Equipment" (WEEE) predicts that every manufacturer of electrical and electronic equipment which is put on the European market has to contribute to the reuse, recycling and other forms of recovery of such waste so as to reduce disposal. Moreover this directive refers to the Directive 2002/95/EC of the European Commission on the "Restriction of the use of certain Hazardous Substances in Electrical and Electronic Equipment" (RoHS).

Having its main focus on private persons and households using such electrical and electronic equipment the directive also affects business-to-business relationships. The directive is quite restrictive on how such waste of private persons and households has to be handled by the supplier/manufacturer; however, it allows a greater flexibility in business-to-business relationships. This pays tribute to the fact with industrial use electrical and electronic products are commonly integrated into larger and more complex environments or systems that cannot easily be split up again when it comes to their disposal at the end of their life cycles.

As N.A.T. products are solely sold to industrial customers, by special arrangement at time of purchase the customer agreed to take the responsibility for a WEEE compliant disposal of the used N.A.T. product. Moreover, all N.A.T. products are marked according to the directive with a crossed out bin to indicate that these products within the European Community must not be disposed with regular waste.

If you have any questions on the policy of N.A.T. regarding the Directive 2011/65/EU of the European Parliament and of the Council of 8 June 2011 on the "Restriction of the use of certain Hazardous Substances in Electrical and Electronic Equipment" (RoHS) or the Directive 2002/95/EC of the European Commission on



"Waste Electrical and Electronic Equipment" (WEEE) please contact N.A.T. by phone or e-mail.

7.3.3. Compliance to CE Directive

Compliance to the CE directive is declared. A 'CE' sign can be found on the PCB.

7.3.4. Product Safety

The board complies with EN60950 and UL1950.

7.3.5. Compliance to REACH

The REACH EU regulation (Regulation (EC) No 1907/2006) is known to N.A.T. GmbH. N.A.T. did not receive information from their European suppliers of substances of very high concern of the ECHA candidate list. Article 7(2) of REACH is notable as no substances are intentionally being released by NAT products and as no hazardous substances are contained. Information remains in effect or will be otherwise stated immediately to our customers.



8. Known Bugs / Restrictions

none



Appendix A: Reference Documentation

- [1] <http://tesla.desy.de/doocs/doocs.html> (click on the MTCA-tab beside home and jddd)
- [2] <http://tesla.desy.de/doocs/Timing/CDRv2.2short.pdf>

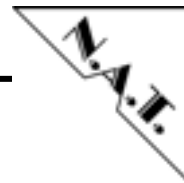

Appendix B: Document's History

Revision	Date	Description	Author
0.1	01.03.2016	initial release	cs (Desy)
1.0	25.05.2016	Transfer to NAT template, add hardware information	vd