

**NAMC-LM
AMC Load Module
Technical Reference Manual V1.2
HW Revision 1.2**

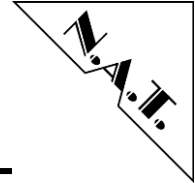

The NAMC-LM has been designed by:

**N.A.T. GmbH
Konrad-Zuse-Platz 9
D-53227 Bonn**

**Phone: +49 / 228 / 965 864 - 0
Fax: +49 / 228 / 965 964 - 10**

Internet: <http://www.nateurope.com>

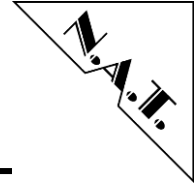

Disclaimer

The following documentation, compiled by N.A.T. GmbH (henceforth called N.A.T.), represents the current status of the product's development. The documentation is updated on a regular basis. Any changes which might ensue, including those necessitated by updated specifications, are considered in the latest version of this documentation. N.A.T. is under no obligation to notify any person, organization, or institution of such changes or to make these changes public in any other way.

We must caution you, that this publication could include technical inaccuracies or typographical errors.

N.A.T. offers no warranty, either expressed or implied, for the contents of this documentation or for the product described therein, including but not limited to the warranties of merchantability or the fitness of the product for any specific purpose.

In no event will N.A.T. be liable for any loss of data or for errors in data utilization or processing resulting from the use of this product or the documentation. In particular, N.A.T. will not be responsible for any direct or indirect damages (including lost profits, lost savings, delays or interruptions in the flow of business activities, including but not limited to, special, incidental, consequential, or other similar damages) arising out of the use of or inability to use this product or the associated documentation, even if N.A.T. or any authorized N.A.T. representative has been advised of the possibility of such damages.

The use of registered names, trademarks, etc. in this publication does not imply, even in the absence of a specific statement, that such names are exempt from the relevant protective laws and regulations (patent laws, trade mark laws, etc.) and therefore free for general use. In no case does N.A.T. guarantee that the information given in this documentation is free of such third-party rights.

Neither this documentation nor any part thereof may be copied, translated, or reduced to any electronic medium or machine form without the prior written consent from N.A.T. GmbH.

This product (and the associated documentation) is governed by the N.A.T. General Conditions and Terms of Delivery and Payment.

Note:

The release of the Hardware Manual is related to a certain HW board revision given in the document title. For HW revisions earlier than the one given in the document title please contact N.A.T. for the corresponding older Hardware Manual release.

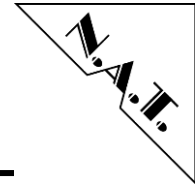
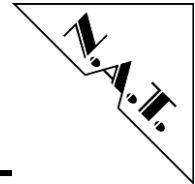

Table of Contents

TABLE OF CONTENTS	4
LIST OF TABLES	5
LIST OF FIGURES	5
CONVENTIONS	6
1 INTRODUCTION	7
2 OVERVIEW	8
2.1 BLOCK DIAGRAM	8
2.2 LOCATION DIAGRAM	9
3 BOARD FEATURES – POWER CONFIGURATION	10
3.1 POWER CONFIGURATION VIA DIP-SW2	10
3.1.1 <i>Pulse Capacity</i>	10
3.1.2 <i>Zone Mode / Interleaved Mode Selection</i>	10
3.1.3 <i>IPMI Configuration</i>	12
3.2 POWER CONFIGURATION VIA IPMI-MESSAGES	12
4 HARDWARE	13
4.1 FRONT PANEL AND LEDs	13
4.2 CONNECTORS AND SWITCHES	14
4.2.1 <i>CON1: AMC Connector</i>	15
4.2.2 <i>JP1: Microcontroller Programming Header</i>	17
4.2.3 <i>DIP-SW2: Power Configuration</i>	17
4.2.4 <i>SW1: Hot-Swap Switch</i>	17
5 BOARD SPECIFICATION	18
6 INSTALLATION	19
6.1 SAFETY NOTE	19
6.2 INSTALLATION PREREQUISITES AND REQUIREMENTS	20
6.2.1 <i>Requirements</i>	20
6.2.2 <i>Power supply</i>	20
6.3 STATEMENT ON ENVIRONMENTAL PROTECTION	21
6.3.1 <i>Compliance to RoHS Directive</i>	21
6.3.2 <i>Compliance to WEEE Directive</i>	21
6.3.3 <i>Compliance to CE Directive</i>	22
6.3.4 <i>Product Safety</i>	22
6.3.5 <i>Compliance to REACH</i>	22
7 KNOWN BUGS / RESTRICTIONS	23
APPENDIX A: IPMI-TOOL EXAMPLE	24
APPENDIX B: REFERENCE DOCUMENTATION	25
APPENDIX C: DOCUMENT’S HISTORY	26



List of Tables

Table 1:	List of used abbreviations	6
Table 2:	Power Configuration – Overview	10
Table 3:	Pulse Mode Selection	10
Table 4:	Zone Mode / Interleaved Mode Selection	10
Table 5:	Load Level – Normal Mode	11
Table 6:	Load Level – Zone Mode	11
Table 7:	Load Level – Interleaved Mode – FW1.7 and higher only	11
Table 8:	IPMI Configuration	12
Table 9:	IPMI command “read register”	12
Table 10:	IPMI command “write register”	12
Table 13:	NAMC-LM Features – Overview	18

List of Figures

Figure 1:	NAMC-LM	7
Figure 2:	NAMC-LM – Block Diagram	8
Figure 3:	NAMC-LM – Location Diagram	9
Figure 4:	NAMC-LM – Front Panel View	13
Figure 5:	NAMC-LM – Connectors and Switches – Overview	14

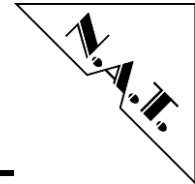

Conventions

If not otherwise specified, addresses and memory maps are written in hexadecimal notation, identified by *0x*.

The following gives a list of the abbreviations used in this document:

Table 1: List of used abbreviations

Abbreviation	Description
AMC	Advanced Mezzanine Card
ATCA	Advanced Telecommunications Computing Architecture
DC	Direct Current
DIP-SW	Dual In-Line Switch
IPMI	Intelligent Platform Management Interface
LM	Load Module
μTCA/MTCA	Micro Telecommunications Computing Architecture
RMCP	Remote Management Control Protocol

1 Introduction

The **NAMC-LM** is a load module card in AMC (Advanced Mezzanine Card) form factor. It is intended for measuring and verifying power supply and cooling concepts of MicroTCA chassis and ATCA carriers. It is easy configurable via an 8 Pin DIP-SW to consume between 0A and 8.0A Payload power at 12V DC voltage. The power level is also configurable via IPMI messages. It is capable of reporting board temperature and current draw via several on-board sensors. Configuring load level via IPMI can be achieved using e.g. NATview version 2.5 or higher.

The following figure shows a photo of the **NAMC-LM**.

Figure 1: NAMC-LM



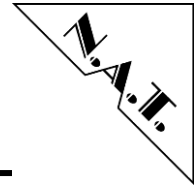

2 Overview

2.1 Block Diagram

The following figure shows a block diagram of the **NAMC-LM**.

Figure 2: NAMC-LM – Block Diagram

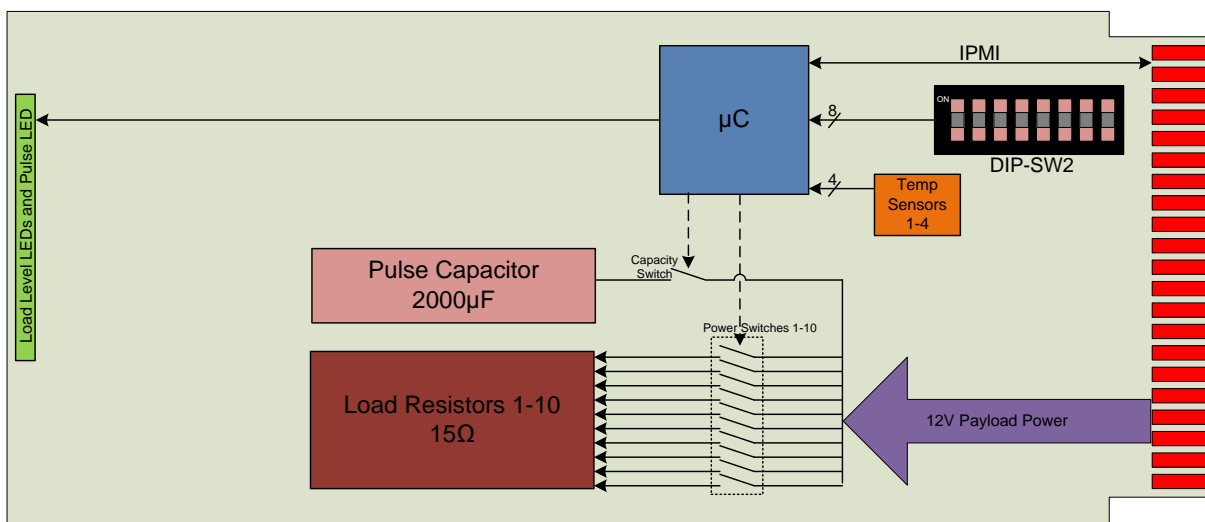

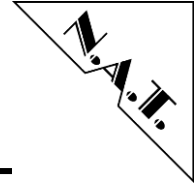

2.2 Location Diagram

The position of important components is shown in the following location overview. Depending on the board type it might be that the board does not include all components named in the location diagram.

Figure 3: NAMC-LM – Location Diagram

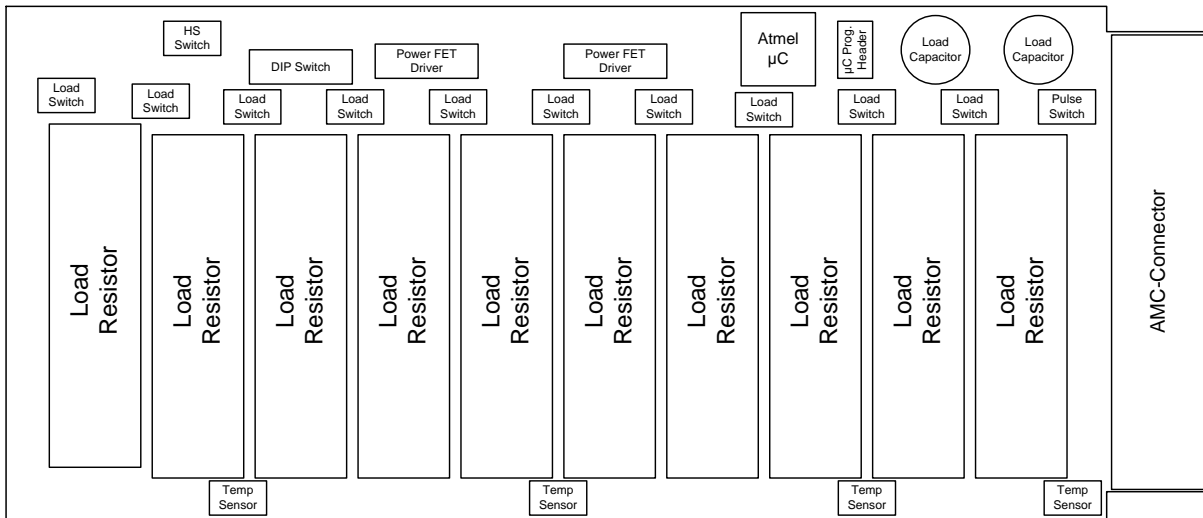

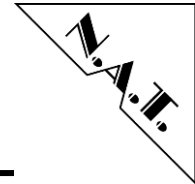

3 Board Features – Power Configuration

This chapter contains a brief description of the power configuration on the **NAMC-LM**.

The Load Configuration Switch DIP-SW2 offers several options to set up the power configuration of the **NAMC-LM**. The table below gives an overview of the functionality; details are described in the following subchapters.

As described in chapter 3.2, the power configuration can be set up as well via software (IPMI Configuration).

Table 2: Power Configuration – Overview

Switch #	Function
1	Load Level (0-96W)
2	
3	
4	
5	Pulse Capacity
6	Mode Selector
7	Zone Mode/ Interleaved Mode (FWv1.7 and higher only)
8	Enable IPMI Configuration

3.1 Power Configuration via DIP-SW2

3.1.1 Pulse Capacity

If the **NAMC-LM** is set to "Pulse Mode", a 2000µF capacitor is charged and de-charged once per second.

Table 3: Pulse Mode Selection

SW2-5	Function
OFF	Pulse Mode DISABLED
ON	Pulse Mode ENABLED

3.1.2 Zone Mode / Interleaved Mode Selection

Table 4: Zone Mode / Interleaved Mode Selection

SW2-7	SW2-6	Function
OFF	OFF	Normal Mode
OFF	ON	Zone Mode ENABLED
ON	OFF	Interleaved Mode ENABLED (firmware V1.7 and higher only)
ON	ON	Reserved

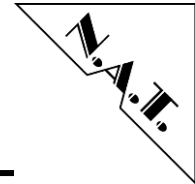

If "Normal Mode" is selected, the load level is determined by SW2-1 – SW2-4 according Table 5:

Table 5: Load Level – Normal Mode

SW2-4	SW2-3	SW2-2	SW2-1	Power Consumption	Current
OFF	OFF	OFF	OFF	0W	0A
OFF	OFF	OFF	ON	9.6W	0.8A
OFF	OFF	ON	OFF	19.2W	1.6A
OFF	OFF	ON	ON	28.8W	2.4A
OFF	ON	OFF	OFF	38.4W	3.6A
OFF	ON	OFF	ON	48W	4.0A
OFF	ON	ON	OFF	57.6W	4.8A
OFF	ON	ON	ON	67.2W	5.6A
ON	OFF	OFF	OFF	76.8W	6.4A
ON	OFF	OFF	ON	86.4W	7.2A
ON	OFF	ON	OFF	96W	8.0A

If the **NAMC-LM** is switched to "Zone Mode", a fixed resistor zone (Front, Mid or Rear) with a fixed load level is determined by SW2-1 – SW2-4 according Table 6:

Table 6: Load Level – Zone Mode

SW2-4	SW2-3	SW2-2	SW2-1	Function	Power Consumption	Current
OFF	OFF	OFF	ON	Enable Front Zone (R17-R19)	28.8W	2.4A
OFF	OFF	ON	OFF	Enable Mid Zone (R20-R27)	38.4W	3.2A
OFF	ON	OFF	OFF	Enable Rear Zone (R31-R37)	28.8W	2.4A

FIRMWARE-VERSION 1.7 AND HIGHER ONLY:

If "Interleaved Mode" is selected, the power is distributed equally across all load resistors of the **NAMC-LM** to have a uniform heat generation over the module area. A fixed load level can be configured by SW2-1 – SW2-4 according Table 7:

Table 7: Load Level – Interleaved Mode – FW1.7 and higher only

SW2-4	SW2-3	SW2-2	SW2-1	Power Consumption	Current
OFF	OFF	OFF	ON	Interleaved 19.2W	1.6A
OFF	OFF	ON	OFF	Interleaved 28.8W	2.4A
OFF	OFF	ON	ON	Interleaved 38.4W	3.2A
OFF	ON	OFF	OFF	Interleaved 48W	4.0A

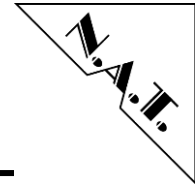

3.1.3 IPMI Configuration

If IPMI configuration is enabled, the load level of the payload power resistors can be changed via IPMI commands; the power requirement is maximum.

Table 8: IPMI Configuration

SW2-8	Function
OFF	IPMI Configuration DISABLED
ON	IPMI Configuration ENABLED

3.2 Power Configuration via IPMI-Messages

As an alternative to using DIP-SW2, the power configuration of the **NAMC-LM** can be changed via software as well. For this purpose N.A.T. has defined a set of two IPMI OEM commands:

- To read the bits corresponding to the 8-bit DIP-SW2, use command "read register" NetFn = 0x30, cmd = 0x01
- To write them, use command "write register", NetFn = 0x30, cmd = 0x02

All bit combinations valid for the hardware DIP-SW2 can be used for this "software DIP-Switch" as well.

Table 9: IPMI command "read register"

Byte	Data field
	Request
0	PICMG Identifier. A value of 0x00 shall be used
1	Register number. Currently only 0x00 is supported
	Response
0	current DIP-switch setting

Table 10: IPMI command "write register"

Byte	Data field
	Request
0	PICMG Identifier. A value of 0x00 shall be used
1	Register number. Currently only 0x00 is supported
2	new DIP-switch setting (Bit[7] is read-only)

For an example, please refer to **Appendix A: IPMI-Tools Example**. For more detailed information, refer to the NATView Documentation.

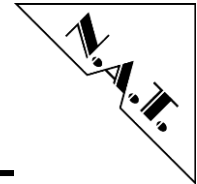

4 Hardware

4.1 Front Panel and LEDs

The **NAT-LM** module is equipped with 10 green LEDs (10W – 100W) indicating the load level. Another green LED signals Pulse Mode.

Figure 4: NAMC-LM – Front Panel View

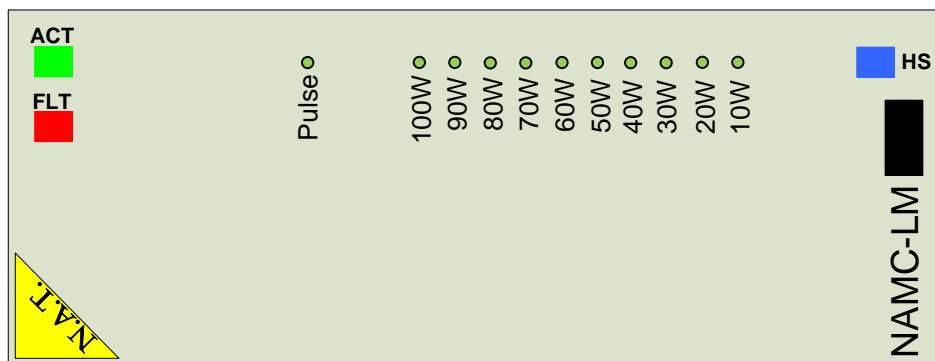

Additionally the module contains the standard AMC LEDs consisting of a red Fault Indication LED, a General Purpose status LED and the Hot-Swap handle with the corresponding blue LED.

The Fault Indication LED turns to "On" if the temperature sensor registers a temperature value falling below or exceeding a threshold level. If the temperature returns to normal value, the LED is switched to "Off" again.

Although optically appearing as one LED, the General Purpose LED physically consists of two LEDs (green and orange) sharing the same hole in the Front Plate.

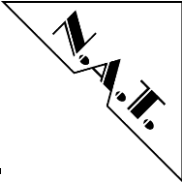

4.2 Connectors and Switches

Figure 5: NAMC-LM – Connectors and Switches – Overview

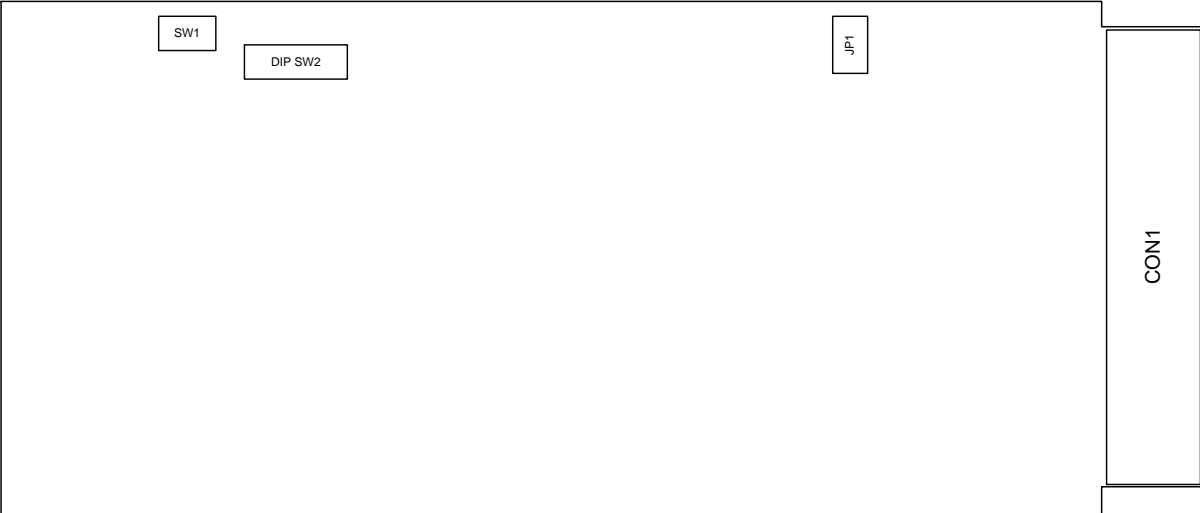

Please refer to the following tables to look up the connector and switch pin assignment of the **NAMC-LM**.

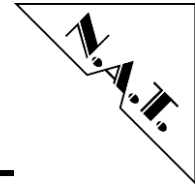

4.2.1 CON1: AMC Connector

Table 11: CON1: AMC Connector – Pin-Assignment

Pin #	AMC-Signal	AMC-Signal	Pin #
1	GND	GND	170
2	+12V	AMC_TDI	169
3	/AMC_PS1	AMC_TDO	168
4	VCC_IMP	/AMC_TRST	167
5	AMC_GA0	AMC_TMS	166
6	nc	AMC_TCK	165
7	GND	GND	164
8	nc	nc	163
9	+12V	nc	162
10	GND	GND	161
11	nc	nc	160
12	nc	nc	159
13	GND	GND	158
14	nc	nc	157
15	nc	nc	156
16	GND	GND	155
17	AMC_GA1	nc	154
18	+12V	nc	153
19	GND	GND	152
20	nc	nc	151
21	nc	nc	150
22	GND	GND	149
23	nc	nc	148
24	nc	nc	147
25	GND	GND	146
26	AMC_GA2	nc	145
27	+12V	nc	144
28	GND	GND	143
29	nc	nc	142
30	nc	nc	141
31	GND	GND	140
32	nc	nc	139
33	nc	nc	138
34	GND	GND	137
35	nc	nc	136
36	nc	nc	135
37	GND	GND	134
38	nc	nc	133
39	nc	nc	132
40	GND	GND	131
41	/AMC_ENABLE	nc	130
42	+12V	nc	129
43	GND	GND	128
44	nc	nc	127

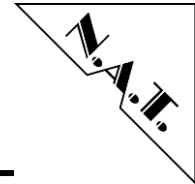

Pin #	AMC-Signal	AMC-Signal	Pin #
45	nc	nc	126
46	GND	GND	125
47	nc	nc	124
48	nc	nc	123
49	GND	GND	122
50	nc	nc	121
51	nc	nc	120
52	GND	GND	119
53	nc	nc	118
54	nc	nc	117
55	GND	GND	116
56	IMPB_SCL	nc	115
57	+12V	nc	114
58	GND	GND	113
59	nc	nc	112
60	nc	nc	111
61	GND	GND	110
62	nc	nc	109
63	nc	nc	108
64	GND	GND	107
65	nc	nc	106
66	nc	nc	105
67	GND	GND	104
68	nc	nc	103
69	nc	nc	102
70	GND	GND	101
71	IMPB_SDA	nc	100
72	+12V	nc	99
73	GND	GND	98
74	nc	nc	97
75	nc	nc	96
76	GND	GND	95
77	nc	nc	94
78	nc	nc	93
79	GND	GND	92
80	nc	nc	91
81	nc	nc	90
82	GND	GND	89
83	/AMC_PS0	nc	88
84	+12V	nc	87
85	GND	GND	86

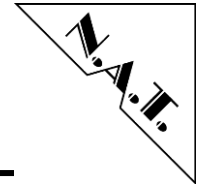

4.2.2 JP1: Microcontroller Programming Header

JP1 is the Atmel Microcontroller Programming Header.

Table 12: JP1: Microcontroller Programming Header – Pin-Assignment

Pin #	Signal	Signal	Pin #
1	ATMEL_MISO	VCC_IMP	2
3	ATMEL_SCK	ATMEL_MOSI	4
5	/RST_IPMI	GND	6

4.2.3 DIP-SW2: Power Configuration

As DIP-SW2 is the central element of configuring the **NAMC-LM**, its functionality is described in a separate chapter (Chapter 3).

4.2.4 SW1: Hot-Swap Switch

Switch SW1 is used to support Hot-Swapping of the module. It conforms to PICMG AMC.0.

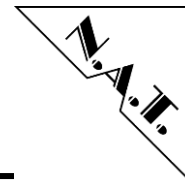

5 Board Specification

Table 13: NAMC-LM Features – Overview

Microcontroller	Atmel ATmega1284
AMC-Module	Advanced Mezzanine Card, single width, full-size or mid-size
Power Consumption (Full Load)	12V / 8.0A
Operating Temperature	0°C – +55°C with forced cooling
Storage Temperature	-40°C - +85°C
Humidity	10% – 90% rh non-condensing
Standards compliance	PICMG AMC.0 Rev. 2.0 IPMI Specification v2.0 Rev. 1.0 PICMG μ TCA.0 Rev. 1.0

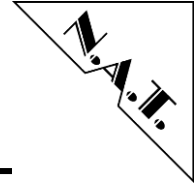

6 Installation

6.1 Safety Note

To ensure proper functioning of the **NAMC-LM** during its usual lifetime take the following precautions before handling the board.

CAUTION

Electrostatic discharge and incorrect board installation and uninstallation can damage circuits or shorten their lifetime.

- Before installing or uninstalling the **NAMC-LM** read this installation section
- Before installing or uninstalling the **NAMC-LM**, read the Installation Guide and the User's Manual of the carrier board used, or of the μ TCA system the board will be plugged into.
- Before installing or uninstalling the **NAMC-LM** on a carrier board or both in a rack:
 - Check all installed boards and modules for steps that you have to take before turning on or off the power.
 - Take those steps
 - Finally turn on or off the power if necessary
 - Make sure the part to be installed / removed is hot swap capable, if you don't switch off the power
- Before touching integrated circuits ensure to take all require precautions for handling electrostatic devices.
- Ensure that the **NAMC-LM** is connected to the carrier board or to the μ TCA backplane with the connector completely inserted.
- When operating the board in areas of strong electromagnetic radiation ensure that the module
 - is bolted the front panel or rack
 - and shielded by closed housing

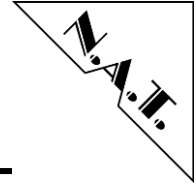

6.2 Installation Prerequisites and Requirements

IMPORTANT

Before powering up check this section for installation prerequisites and requirements!

6.2.1 Requirements

The installation requires only:

- an ATCA carrier board, or a μ TCA backplane for connecting the **NAMC-LM**
- power supply
- cooling devices

6.2.2 Power supply

The power supply for the **NAMC-LM** must meet the following specifications:

- required for the module: +12V / 8.0A max.

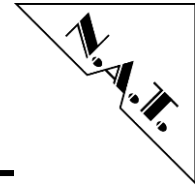

6.3 Statement on Environmental Protection

6.3.1 Compliance to RoHS Directive

Directive 2011/65/EU of the European Parliament and of the Council of 8 June 2011 on the "Restriction of the use of certain Hazardous Substances in Electrical and Electronic Equipment" (RoHS) predicts that all electrical and electronic equipment being put on the European market after June 30th, 2006 must contain lead, mercury, hexavalent chromium, polybrominated biphenyls (PBB) and polybrominated diphenyl ethers (PBDE) and cadmium in maximum concentration values of 0.1% respective 0.01% by weight in homogenous materials only.

As these hazardous substances are currently used with semiconductors, plastics (i.e. semiconductor packages, connectors) and soldering tin any hardware product is affected by the RoHS directive if it does not belong to one of the groups of products exempted from the RoHS directive.

Although many of hardware products of N.A.T. are exempted from the RoHS directive it is a declared policy of N.A.T. to provide all products fully compliant to the RoHS directive as soon as possible. For this purpose since January 31st, 2005 N.A.T. is requesting RoHS compliant deliveries from its suppliers. Special attention and care has been paid to the production cycle, so that wherever and whenever possible RoHS components are used with N.A.T. hardware products already.

6.3.2 Compliance to WEEE Directive

Directive 2002/95/EC of the European Commission on "Waste Electrical and Electronic Equipment" (WEEE) predicts that every manufacturer of electrical and electronic equipment which is put on the European market has to contribute to the reuse, recycling and other forms of recovery of such waste so as to reduce disposal. Moreover this directive refers to the Directive 2002/95/EC of the European Commission on the "Restriction of the use of certain Hazardous Substances in Electrical and Electronic Equipment" (RoHS).

Having its main focus on private persons and households using such electrical and electronic equipment the directive also affects business-to-business relationships. The directive is quite restrictive on how such waste of private persons and households has to be handled by the supplier/manufacturer; however, it allows a greater flexibility in business-to-business relationships. This pays tribute to the fact with industrial use electrical and electronic products are commonly integrated into larger and more complex environments or systems that cannot easily be split up again when it comes to their disposal at the end of their life cycles.

As N.A.T. products are solely sold to industrial customers, by special arrangement at time of purchase the customer agreed to take the responsibility for a WEEE compliant disposal of the used N.A.T. product. Moreover, all N.A.T. products are marked according to the directive with a crossed out bin to indicate that these products within the European Community must not be disposed with regular waste.

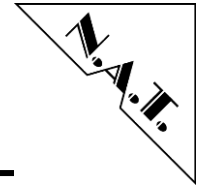

If you have any questions on the policy of N.A.T. regarding the Directive 2011/65/EU of the European Parliament and of the Council of 8 June 2011 on the "Restriction of the use of certain Hazardous Substances in Electrical and Electronic Equipment" (RoHS) or the Directive 2002/95/EC of the European Commission on "Waste Electrical and Electronic Equipment" (WEEE) please contact N.A.T. by phone or e-mail.

6.3.3 Compliance to CE Directive

Compliance to the CE directive is declared. A 'CE' sign can be found on the PCB.

6.3.4 Product Safety

The board complies with EN60950 and UL1950.

6.3.5 Compliance to REACH

The REACH EU regulation (Regulation (EC) No 1907/2006) is known to N.A.T. GmbH. N.A.T. did not receive information from their European suppliers of substances of very high concern of the ECHA candidate list. Article 7(2) of REACH is notable as no substances are intentionally being released by NAT products and as no hazardous substances are contained. Information remains in effect or will be otherwise stated immediately to our customers.

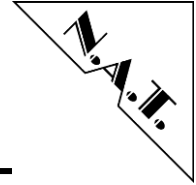

7 Known Bugs / Restrictions

none

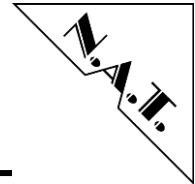

Appendix A: IPMI-Tool Example

As described in chapter 3.2 the **NAMC-LM** can be configured via hardware (DIP-SW2) or software (IPMI messages). For software configuration an external software like IPMI-Tool can be used to send bridged messages to the **NAMC-LM** e.g. via RMCP.

To read the current value of DIP-SW2 (if the **NAMC-LM** is located in AMC slot 1) the syntax would be as follows:

```
ipmitool.exe -H 192.168.1.123 -P "" -T 0x82 -B 0 -t 0x72 -b 7 raw 0x30 0x01 0 0 0
```

To set the load level to 4 the parameters are the following:

```
ipmitool.exe -H 192.168.1.123 -P "" -T 0x82 -B 0 -t 0x72 -b 7 raw 0x30 0x02 0 0 0 x04
```

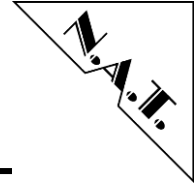
Appendix B: Reference Documentation

- [1] Atmel Microcontroller, Datasheet, Rev. 8059D - 11/09
- [2] NATView Documentation, V2.17 - 11/2014

