

**NAMC-EXT
NAMC-EXT-PS
AMC Extender Module
Technical Reference Manual V1.6
HW Revision 1.5**

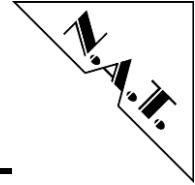

The NAMC-EXT has been designed by:

**N.A.T. GmbH
Konrad-Zuse-Platz 9
D-53227 Bonn-Oberkassel**

Phone: ++49 / 228 / 965 864 - 0

Fax: ++49/ 228 / 965 864 - 10

Internet: <http://www.nateurope.com>

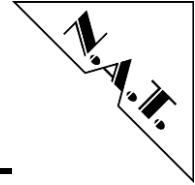

Disclaimer

The following documentation, compiled by N.A.T. GmbH (henceforth called N.A.T.), represents the current status of the product's development. The documentation is updated on a regular basis. Any changes which might ensue, including those necessitated by updated specifications, are considered in the latest version of this documentation. N.A.T. is under no obligation to notify any person, organization, or institution of such changes or to make these changes public in any other way.

We must caution you, that this publication could include technical inaccuracies or typographical errors.

N.A.T. offers no warranty, either expressed or implied, for the contents of this documentation or for the product described therein, including but not limited to the warranties of merchantability or the fitness of the product for any specific purpose.

In no event will N.A.T. be liable for any loss of data or for errors in data utilization or processing resulting from the use of this product or the documentation. In particular, N.A.T. will not be responsible for any direct or indirect damages (including lost profits, lost savings, delays or interruptions in the flow of business activities, including but not limited to, special, incidental, consequential, or other similar damages) arising out of the use of or inability to use this product or the associated documentation, even if N.A.T. or any authorized N.A.T. representative has been advised of the possibility of such damages.

The use of registered names, trademarks, etc. in this publication does not imply, even in the absence of a specific statement, that such names are exempt from the relevant protective laws and regulations (patent laws, trade mark laws, etc.) and therefore free for general use. In no case does N.A.T. guarantee that the information given in this documentation is free of such third-party rights.

Neither this documentation nor any part thereof may be copied, translated, or reduced to any electronic medium or machine form without the prior written consent from N.A.T. GmbH.

This product (and the associated documentation) is governed by the N.A.T. General Conditions and Terms of Delivery and Payment.

Note:

The release of the Hardware Manual is related to a certain HW board revision given in the document title. For HW revisions earlier than the one given in the document title please contact N.A.T. for the corresponding older Hardware Manual release.

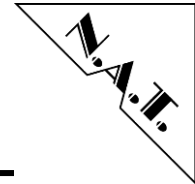
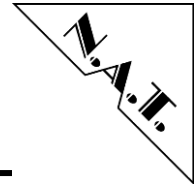

Table of Contents

TABLE OF CONTENTS	4
LIST OF TABLES	5
LIST OF FIGURES	5
CONVENTIONS	6
1 INTRODUCTION	7
2 OVERVIEW	9
2.1 BLOCK DIAGRAM	9
2.2 LOCATION DIAGRAM	10
2.3 DIMENSIONS	12
3 BOARD FEATURES	13
3.1 BUS INTERFACE	13
3.2 POWER SUPPLY	13
4 HARDWARE	14
4.1 AMC PORT DEFINITION	14
4.2 CONNECTORS, JUMPERS AND WIRE BRIDGES	15
4.2.1 J1/JP1: AMC Connectors	16
4.2.2 Jumper JP2	18
4.2.3 Jumper JP3 (NAMC-EXT-PS only)	18
4.2.4 Wire Bridges	19
4.3 TEST POINTS	19
5 BOARD SPECIFICATIONS	20
6 INSTALLATION	21
6.1 SAFETY NOTE	21
6.2 INSTALLATION REQUIREMENTS	21
6.2.1 Requirements	21
6.2.2 Power supply	21
6.3 STATEMENT ON ENVIRONMENTAL PROTECTION	22
6.3.1 Compliance to RoHS Directive	22
6.3.2 Compliance to WEEE Directive	22
6.3.3 Compliance to CE Directive	23
6.3.4 Product Safety	23
6.3.5 Compliance to REACH	23
7 KNOWN BUGS / RESTRICTIONS	24
APPENDIX A: DOCUMENT'S HISTORY	25



List of Tables

Table 1:	List of used abbreviations	6
Table 2:	AMC Port Definition for N.A.T. AMC Modules	14
Table 3:	J1/JP1: AMC Connectors – Pin Assignment	16
Table 4:	Wire Bridges	19
Table 5:	NAMC-EXT: Board Specifications.....	20

List of Figures

Figure 1:	NAMC-EXT	7
Figure 2:	Mechanical Installation in a Chassis.....	8
Figure 3:	NAMC-EXT-PS – Block Diagram	9
Figure 4:	NAMC-EXT – Location Diagram (top left side)	10
Figure 5:	NAMC-EXT – Location Diagram (bottom left side).....	11
Figure 6:	NAMC-EXT – Dimensions	12
Figure 7:	NAMC-EXT – Connectors	15

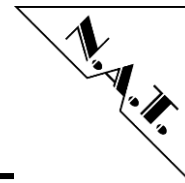

Conventions

If not otherwise specified, addresses and memory maps are written in hexadecimal notation, identified by 0x.

The following table gives a list of the abbreviations used in this document.

Table 1: List of used abbreviations

Abbreviation	Description
AMC	Advanced Mezzanine Card
ATCA	Advanced Telecommunications Computing Architecture
BUT	Board Under Test
CLK	Clock
E1	PDH signal – data rate 2.048 Mbit/s
GND	Ground
H.110	Timeslot Interchange Bus
I/O	Input/Output
IPMB	Intelligent Platform Management Bus
LED	Light Emitting Diode
μTCA/MTCA	Micro Telecommunications Computing Architecture
P2P	Peer-To-Peer
SMD	Surface Mounted Device
SPI	Serial Peripheral Interface
TCKL	Telecom Clock
TDM	Time Division Multiplex

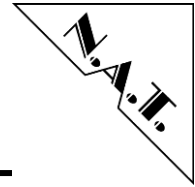

1 Introduction

The **NAMC-EXT** is an extender card for standard AMCs, single width, double height. It can be plugged onto any ATCA carrier board supporting AMC standards. It is also designed to meet the requirements of μ TCA systems.

It eases debugging of AMC boards by enabling the user to access the module under test from both sides, install debug port cables, and allow access for measurement of power supplies.

Please note: As an assembly option the board can be equipped with an on-board +3.3V power supply for generating +3.3V Management Power from +12V Payload Power, so the module under test can be operated with an external +12V power supply only (**NAMC-EXT-PS**).

For reasons of simplification this manual refers to the notation **NAMC-EXT** if common functionality is described. If the behaviour differs on the variants, differences are described for each variant separately.

The following figure shows a photo of the **NAMC-EXT**. It is equipped with two AMC-Connectors; one on the rear side to connect to the backplane of the chassis and the other one – surrounded by a guide rail – for insertion of the front AMC.

Figure 1: NAMC-EXT

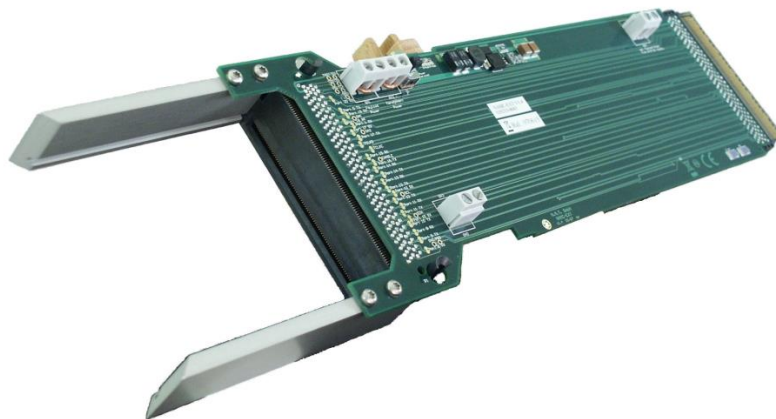

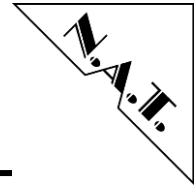

Mechanical installation of the **NAMC-EXT** is shown in the figure below.

Figure 2: Mechanical Installation in a Chassis

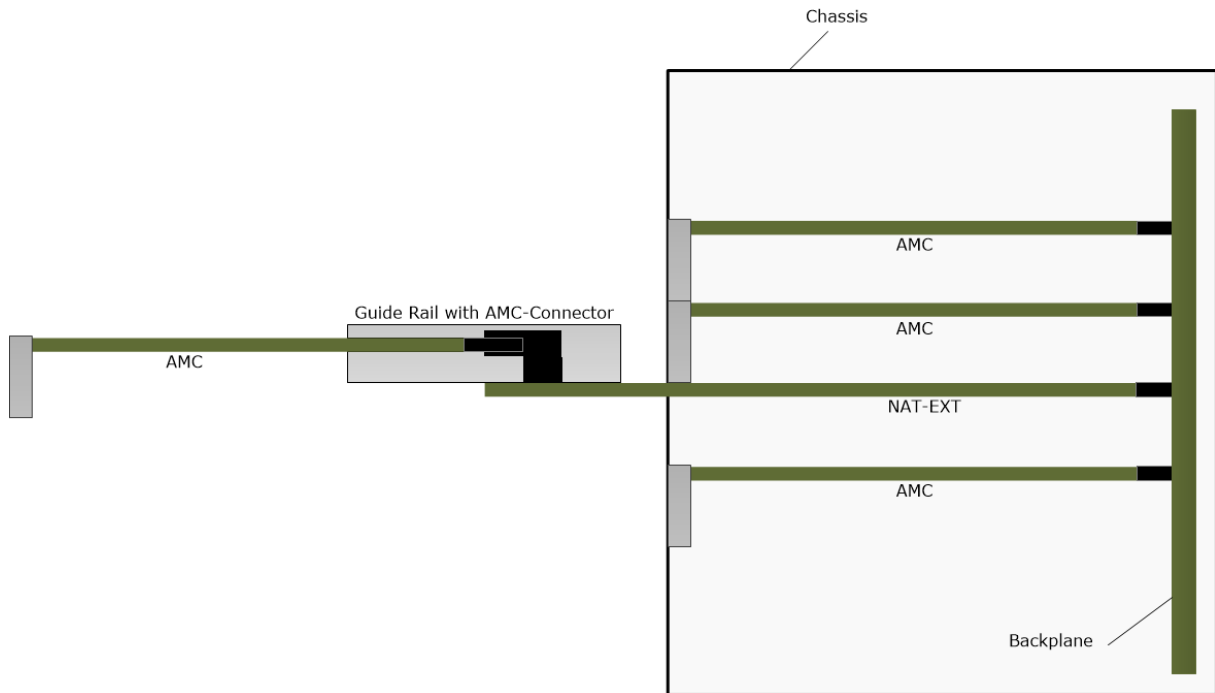

For detailed information about the dimensions of the **NAT-EXT**, please refer to chapter 2.3.

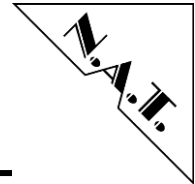

2 Overview

The **NAMC-EXT** is a passive extender board, it does not contain any circuitry. The **NAMC-EXT-PS** features an on-board +3.3V power supply for generating Management Power from Payload Power, so the module under test can be operated with an external +12V power supply only.

2.1 Block Diagram

The following figure shows a block diagram of the **NAMC-EXT-PS** with the optional power supply.

Figure 3: NAMC-EXT-PS – Block Diagram

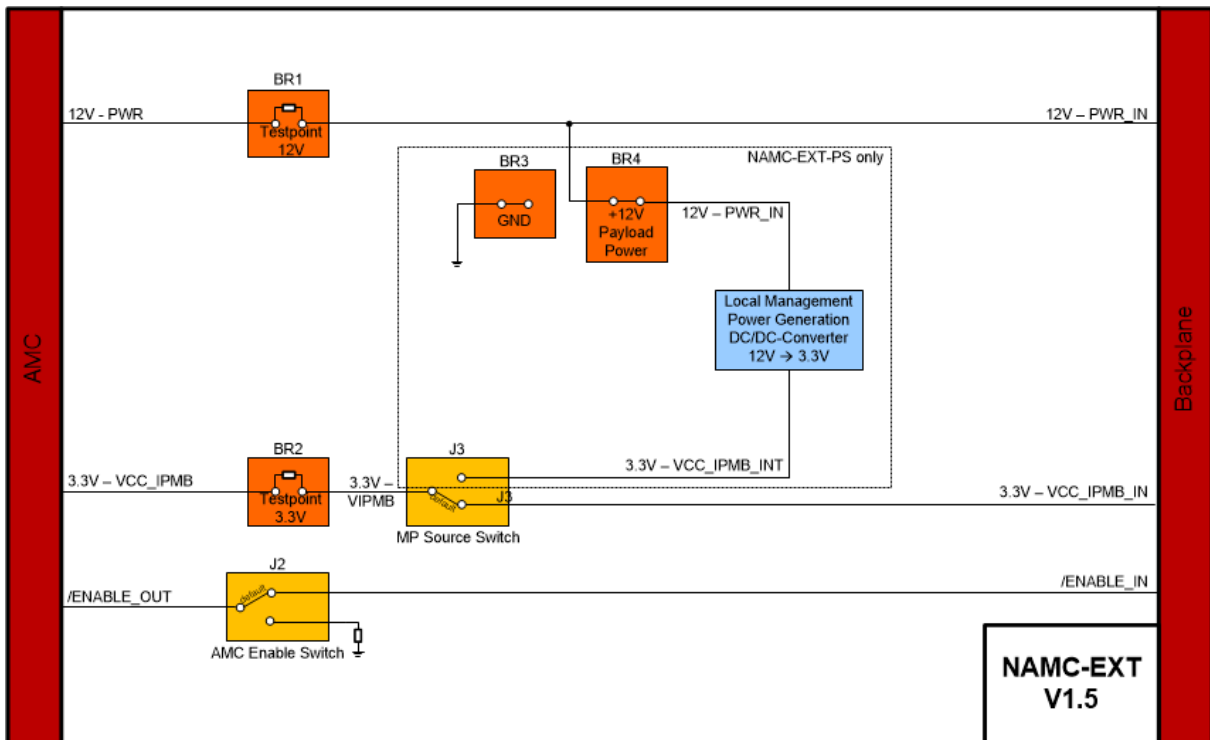

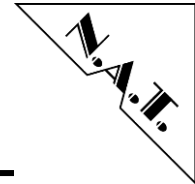

2.2 Location Diagram

The following figures highlight the position of the important components. Depending on the board type it might be that the board does not include all components named in the location diagrams. This applies in particular to the optional +3.3V power supply of the **NAMC-EXT-PS**.

Figure 4: NAMC-EXT – Location Diagram (top left side)

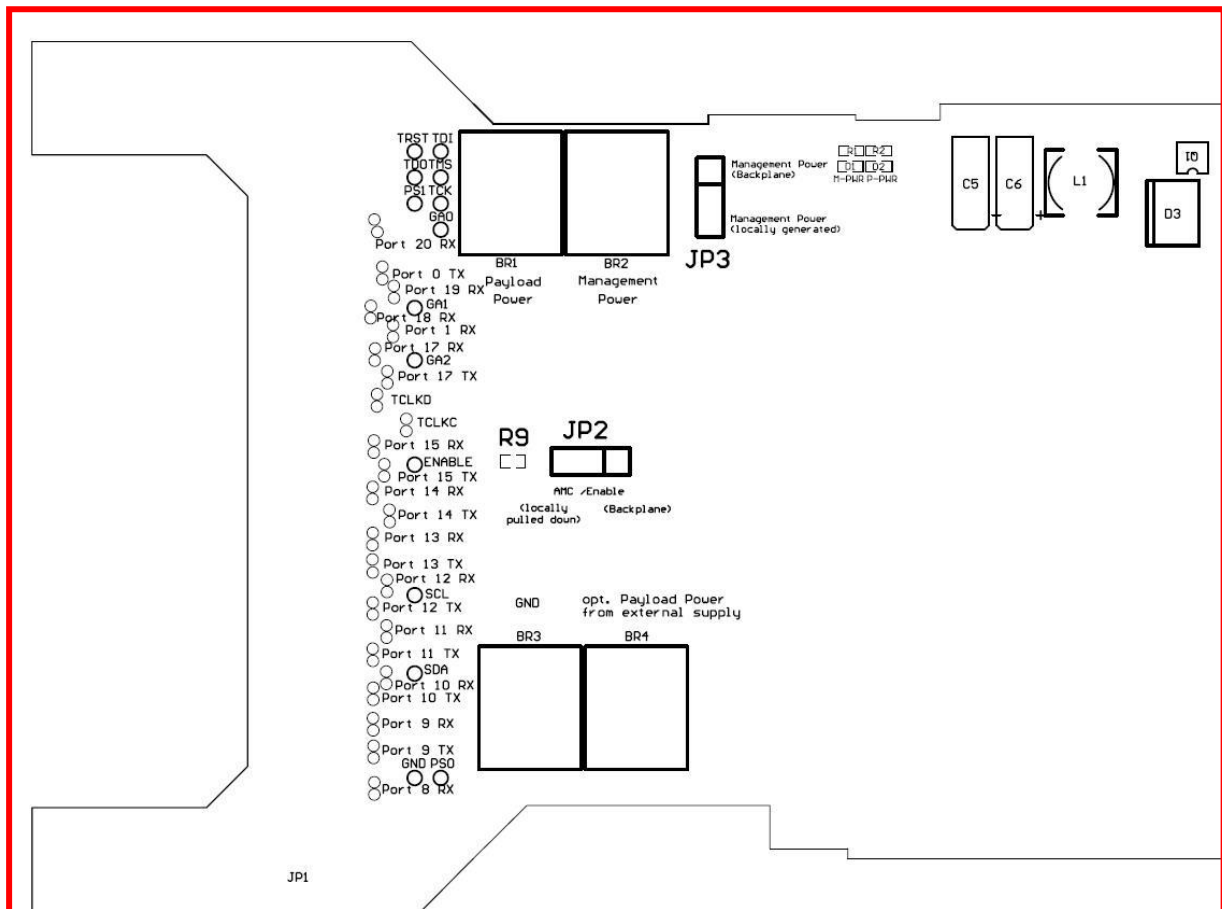

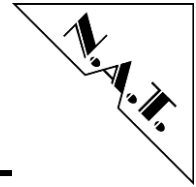
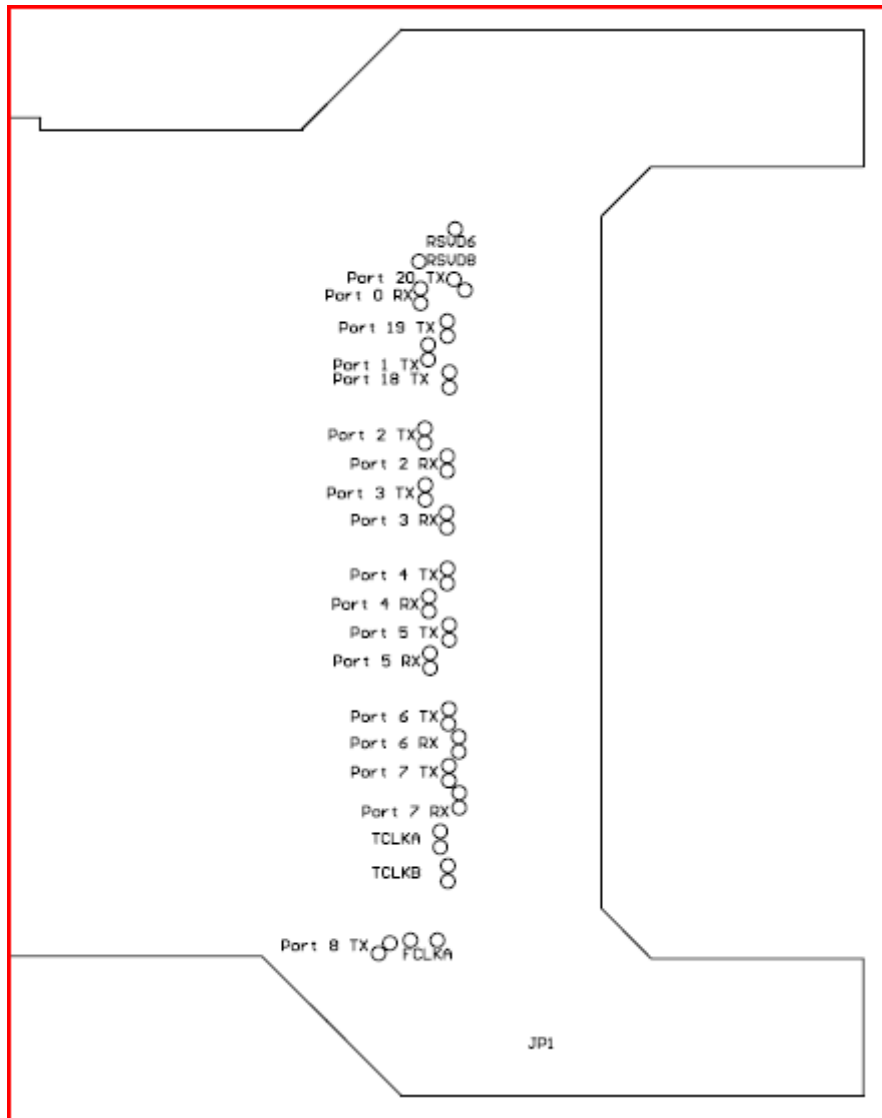
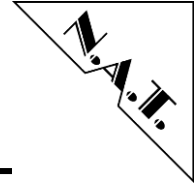

Figure 5: NAMC-EXT – Location Diagram (bottom left side)





2.3 Dimensions

The main function of the **NAMC-EXT** is to allow access for measuring and debugging purposes to a standard AMC. Hence connector JP1 (that picks up the AMC) and all measuring points are located on the extended part outside the chassis.

To allow this it is inevitable that the extended area varies from the outlines defined in the AMC.0 specification, whereas the part that fits into the chassis still complies with the defined dimensions. Figure 6: The following figure shows the dimensions of the **NAMC-EXT**.

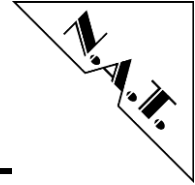
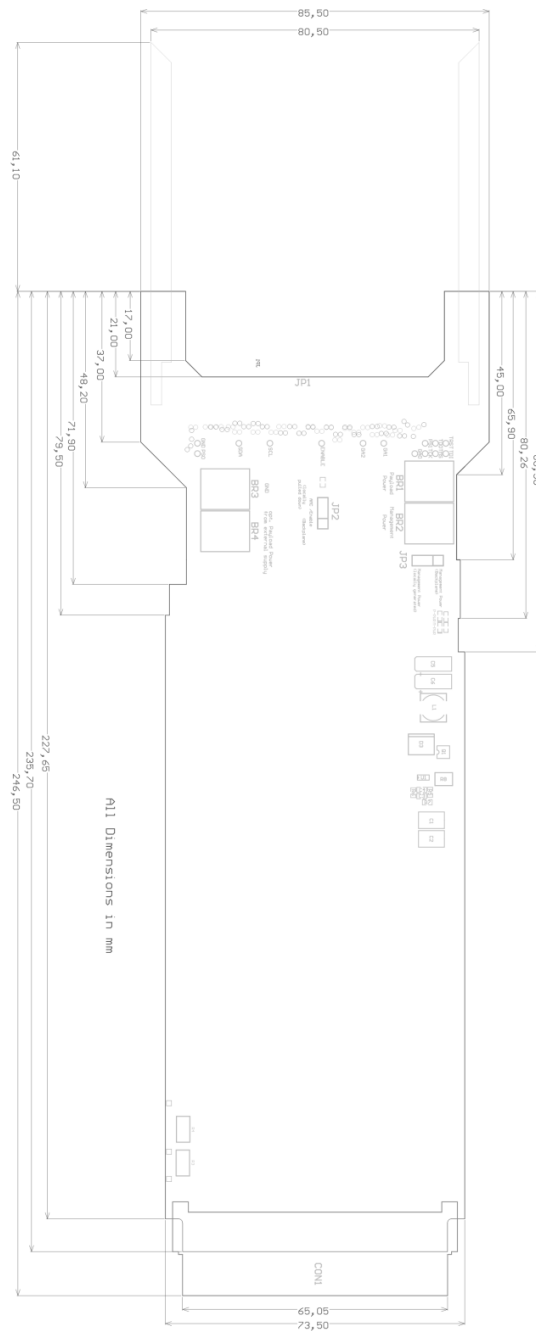
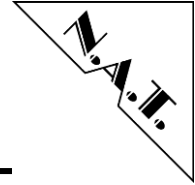

Figure 6: NAMC-EXT – Dimensions





3 Board Features

3.1 Bus Interface

- All AMC ports connected

3.2 Power Supply

- The **NAMC-EXT** draws very little power from the carrier supplies. Current drawn from +3.3V and +12V is less than 10mA each.
- Power planes for GND, payload power and management power.
- Both power supplies drive signalling LEDs.
- Both power supplies may be cut by opening wire bridges for current measurements.
- On the **NAMC-EXT-PS** +3.3V Management power may either be taken from the backplane or generated locally from Payload Power (assembly option).
- Payload Power may either be taken from the backplane or a +12V power supply may be connected to wire bridge BR4.

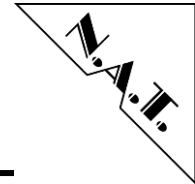

4 Hardware

4.1 AMC Port Definition

Table 2: AMC Port Definition for N.A.T. AMC Modules

	Port #	AMC Port Mapping Strategy	Port used as
Basic Connector	CLK1	Clocks	Universal Clock Signal, depends on used AMC
	CLK2		Universal Clock Signal, depends on used AMC
	CLK3		Universal Clock Signal, depends on used AMC
	0	Common Options Region	Not specified, depends on used AMC
	1		Not specified, depends on used AMC
	2		Not specified, depends on used AMC
	3		Not specified, depends on used AMC
	4	Fat Pipes	Not specified, depends on used AMC
	5		Not specified, depends on used AMC
	6		Not specified, depends on used AMC
7	Not specified, depends on used AMC		
Extended Connector	8	Region	Not specified, depends on used AMC
	9		Not specified, depends on used AMC
	10		Not specified, depends on used AMC
	11		Not specified, depends on used AMC
	12	Extended Options Region	Not specified, depends on used AMC
	13		Not specified, depends on used AMC
	14		Not specified, depends on used AMC
	15		Not specified, depends on used AMC
	16		TCLKC / TCLKD
	17		Not specified, depends on used AMC
	18		Not specified, depends on used AMC
	19		Not specified, depends on used AMC
20	Not specified, depends on used AMC		

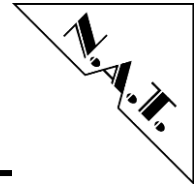

4.2 Connectors, Jumpers and Wire Bridges

There are 2 connectors and 3 wire bridges on the **NAMC-EXT**. Connector J1 is a direct connector and fits into the ATCA or μ TCA AMC slot. Connector JP1 is the socket into which the device under test is plugged. The figure below shows the connectors, as well as the wire bridges:

Figure 7: NAMC-EXT – Connectors

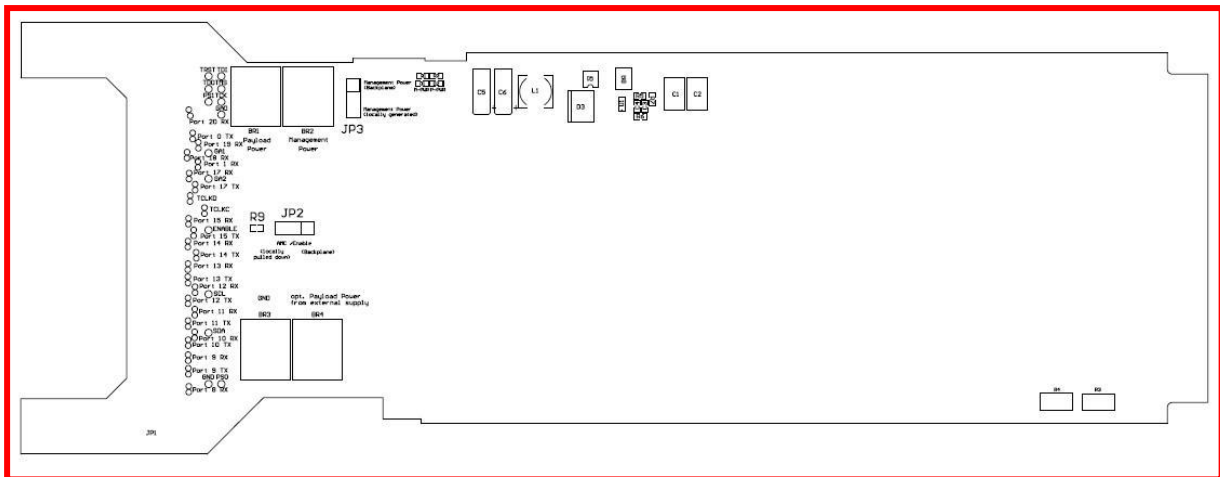

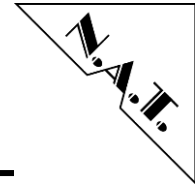

4.2.1 J1/JP1: AMC Connectors

Table 3: J1/JP1: AMC Connectors – Pin Assignment

Pin #	AMC-Signal	AMC-Signal	Pin #
1	GND	GND	170
2	PWR	TDI	169
3	/PS1	TDO	168
4	PWR_IPMB	/TRST	167
5	GA0	TMS	166
6	RESVD	TCK	165
7	GND	GND	164
8	RESVD	Tx20+	163
9	PWR	Tx20-	162
10	GND	GND	161
11	Tx0+	Rx20+	160
12	Tx0-	Rx20-	159
13	GND	GND	158
14	Rx0+	Tx19+	157
15	Rx0-	Tx19-	156
16	GND	GND	155
17	GA1	Rx19+	154
18	PWR	Rx19-	153
19	GND	GND	152
20	Tx1+	Tx18+	151
21	Tx1-	Tx18-	150
22	GND	GND	149
23	RLINK2_P	Rx18+	148
24	RLINK2_N	Rx18-	147
25	GND	GND	146
26	GA2	Tx17+	145
27	PWR	Tx17-	144
28	GND	GND	143
29	Tx2+	Rx17+	142
30	Tx2-	Rx17-	141
31	GND	GND	140
32	Rx2+	Tx16+	139
33	Rx2-	Tx16-	138
34	GND	GND	137
35	Tx3+	Rx16+	136
36	Tx3-	Rx16-	135
37	GND	GND	134
38	Rx3+	Tx15+	133
39	Rx3-	Tx15-	132
40	GND	GND	131
41	/ENABLE	Rx15+	130
42	PWR	Rx15-	129
43	GND	GND	128
44	Tx4+	Tx14+	127
45	Tx4-	Tx14-	126
46	GND	GND	125

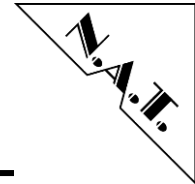

Pin #	AMC-Signal	AMC-Signal	Pin #
47	Rx4+	Rx14+	124
48	Rx4-	Rx14-	123
49	GND	GND	122
50	Tx5+	Tx13+	121
51	Tx5-	Tx13-	120
52	GND	GND	119
53	Rx5+	Rx13+	118
54	Rx5-	Rx13-	117
55	GND	GND	116
56	IPMB_SCL	Tx12+	115
57	PWR	Tx12-	114
58	GND	GND	113
59	Tx6+	Rx12+	112
60	Tx6-	Rx12-	111
61	GND	GND	110
62	Rx6+	Tx11+	109
63	Rx6-	Tx11-	108
64	GND	GND	107
65	Tx7+	Rx11+	106
66	Tx7-	Rx11-	105
67	GND	GND	104
68	Rx7+	Tx10+	103
69	Rx7-	Tx10-	102
70	GND	GND	101
71	IPMB_SDA	Rx10+	100
72	PWR	Rx10-	99
73	GND	GND	98
74	TCLKA+	Tx9+	97
75	TCLKA-	Tx9-	96
76	GND	GND	95
77	TCLKB+	Rx9+	94
78	TCLKB-	Rx9-	93
79	GND	GND	92
80	FCLKA+	Tx8+	91
81	FCLKA-	Tx8-	90
82	GND	GND	89
83	/PS0	Rx8+	88
84	PWR	Rx8-	87
85	GND	GND	86

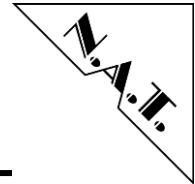

4.2.2 Jumper JP2

The setting of jumper JP2 defines the source for /AMC_ENABLE signal. The default position (right aligned) means the signal is connected to the backplane. In the left aligned position the signal is pulled down locally on the extender board.

4.2.3 Jumper JP3 (NAMC-EXT-PS only)

The setting of jumper JP3 defines the source of Management Power. By default, Management Power is taken from the backplane (jumper JP3 in the upper position). In case there is no Management Power available (e.g. a test assembly with just a +12V supply), Management Power can be generated on-board from the +12V Payload Power. In order to make use of this feature, set jumper JP3 to the lower position.

Upper position:

Management Power taken from backplane

Lower position:

Management Power generated locally

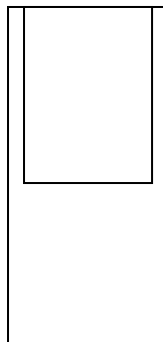

Please note: The function of Jumper JP3 is only valid on the **NAMC-EXT-PS**.

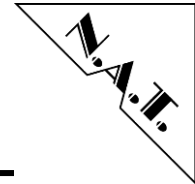

4.2.4 Wire Bridges

The wire bridges BR1 and BR2 connect the supply voltages. The supply current can be measured between both contacts of one bridge if the respective wire bridge is opened.

Please note: Instead of using a simple ampere meter it is recommended to insert a shunt resistor (e.g. 10 mΩ) between the contacts and measure the voltage drop to calculate the current or to monitor it on an oscilloscope.

Both contacts of BR3 are connected to ground; it can be used as a reference contact for measuring and/or to connect an external power supply (**NAMC-EXT-PS** only).

Both contacts of BR4 are connected to +12V Payload Power; it can be used to connect an external power supply to the extender board (**NAMC-EXT-PS** only).

The following table gives an overview of the wire bridges and the supplies they connect.

Table 4: Wire Bridges

Supply	Wire Bridge
+12V Payload Power	BR1
+3.3V Management Power	BR2
GND (reference point or external supply)	BR3
+12V Payload Power (external supply)	BR4

4.3 Test points

There are a number of test points available on the **NAMC-EXT**. Due to layout reasons there are only small SMD test points for the differential signals. All other signals (e.g. geographical address, IPMB signals, etc.) are routed to standard test points, into which standard 100 mil header connectors may be assembled. By default, there are no headers assembled. The names of the signals carried by the test points are printed on the silkscreen.

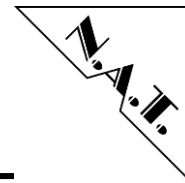

5 Board Specifications

Table 5: NAMC-EXT: Board Specifications

AMC-Module	Extender for Standard Advanced Mezzanine Cards, single width, double height
Power Consumption (NAMC-EXT only)	+3.3V / 0.01A typical +12V / 0.01A typical
Operating Temperature	-40°C - +85°C
Storage Temperature	-40°C - +85°C
Humidity	5% - 90% rh non-condensing

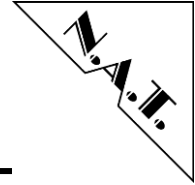

6 Installation

6.1 Safety Note

To ensure proper functioning of the **NAMC-EXT** during its usual lifetime take the following precautions before handling the board.

CAUTION

Electrostatic discharge and incorrect board installation and uninstallation can damage circuits or shorten their lifetime.

- Before installing or uninstalling the **NAMC-EXT** read this installation section
- Before installing or uninstalling the **NAMC-EXT** in a rack:
 - Check all installed boards and modules for steps that you have to take before turning on or off the power.
 - Take those steps.
 - Finally turn on or off the power.
- Before touching integrated circuits ensure to take all require precautions for handling electrostatic devices.

6.2 Installation Requirements

IMPORTANT

Before powering up check this section for installation prerequisites and requirements!

6.2.1 Requirements

The installation requires only

- an AMC backplane for connecting the **NAMC-EXT**.
This can be either an ATCA carrier board or a μ TCA backplane
- a power supply

6.2.2 Power supply

The power supply for the **NAMC-EXT** must meet the following specifications:

- required for the extender board:
 - +3.3V / 0.01A typical
 - +12V / 0.01A typical
- required for the board under test:
 - refer to the BUT power specification

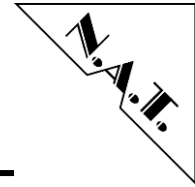

6.3 Statement on Environmental Protection

6.3.1 Compliance to RoHS Directive

Directive 2011/65/EU of the European Parliament and of the Council of 8 June 2011 on the "Restriction of the use of certain Hazardous Substances in Electrical and Electronic Equipment" (RoHS) predicts that all electrical and electronic equipment being put on the European market after June 30th, 2006 must contain lead, mercury, hexavalent chromium, polybrominated biphenyls (PBB) and polybrominated diphenyl ethers (PBDE) and cadmium in maximum concentration values of 0.1% respective 0.01% by weight in homogenous materials only.

As these hazardous substances are currently used with semiconductors, plastics (i.e. semiconductor packages, connectors) and soldering tin any hardware product is affected by the RoHS directive if it does not belong to one of the groups of products exempted from the RoHS directive.

Although many of hardware products of N.A.T. are exempted from the RoHS directive it is a declared policy of N.A.T. to provide all products fully compliant to the RoHS directive as soon as possible. For this purpose since January 31st, 2005 N.A.T. is requesting RoHS compliant deliveries from its suppliers. Special attention and care has been payed to the production cycle, so that wherever and whenever possible RoHS components are used with N.A.T. hardware products already.

6.3.2 Compliance to WEEE Directive

Directive 2002/95/EC of the European Commission on "Waste Electrical and Electronic Equipment" (WEEE) predicts that every manufacturer of electrical and electronic equipment which is put on the European market has to contribute to the reuse, recycling and other forms of recovery of such waste so as to reduce disposal. Moreover this directive refers to the Directive 2002/95/EC of the European Commission on the "Restriction of the use of certain Hazardous Substances in Electrical and Electronic Equipment" (RoHS).

Having its main focus on private persons and households using such electrical and electronic equipment the directive also affects business-to-business relationships. The directive is quite restrictive on how such waste of private persons and households has to be handled by the supplier/manufacturer, however, it allows a greater flexibility in business-to-business relationships. This pays tribute to the fact with industrial use electrical and electronic products are commonly integrated into larger and more complex environments or systems that cannot easily be split up again when it comes to their disposal at the end of their life cycles.

As N.A.T. products are solely sold to industrial customers, by special arrangement at time of purchase the customer agreed to take the responsibility for a WEEE compliant disposal of the used N.A.T. product. Moreover, all N.A.T. products are marked according to the directive with a crossed out bin to indicate that these products within the European Community must not be disposed with regular waste.

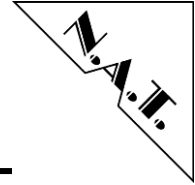

If you have any questions on the policy of N.A.T. regarding the Directive 2011/65/EU of the European Parliament and of the Council of 8 June 2011 on the "Restriction of the use of certain Hazardous Substances in Electrical and Electronic Equipment" (RoHS) or the Directive 2002/95/EC of the European Commission on "Waste Electrical and Electronic Equipment" (WEEE) please contact N.A.T. by phone or e-mail.

6.3.3 Compliance to CE Directive

Compliance to the CE Directive is declared. A 'CE' sign can be found on the PCB.

6.3.4 Product Safety

The board complies to EN60950 and UL1950.

6.3.5 Compliance to REACH

The REACH EU regulation (Regulation (EC) No 1907/2006) is known to N.A.T. GmbH. N.A.T. did not receive information from their European suppliers of substances of very high concern of the ECHA candidate list. Article 7(2) of REACH is notable as no substances are intentionally being released by NAT products and as no hazardous substances are contained. Information remains in effect or will be otherwise stated immediately to our customers.

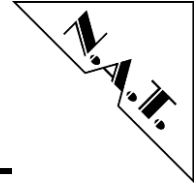

7 Known Bugs / Restrictions

none

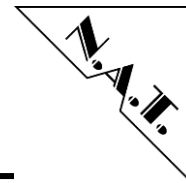

Appendix A: Document's History

Revision	Date	Description	Author
1.0	05.01.2007	initial revision	ga
1.1	14.03.2007	adapted to HW Release 1.3 and to AMC Spec R. 2.0	ga
1.2	02.05.2007	adapted to HW Release 1.4	ga
1.3	26.06.2007	altered naming of signals to be board-independent	te
1.4	10.06.2008	adapted to HW Release 1.5	te
1.5	14.11.2011	Added chapter 4.4 Dimensions	Ks
1.6	17.05.2013	Address, phone and fax , words updated	Fh
	18.08.2014	Adaption to new layout incl. renaming of headings Minor changes, typo correction Updated chapter 6.3 RoHS-Directive / REACH	se
	1.09.2014	Added -PS option Added installation drawing Added Block Diagram	Se
	17.09.2014	Update Block Diagram Reworked Chapter 4.2.4	se